

*Electromagnetic Emissions Test Report
Application for Grant of Equipment Authorization
pursuant to
Industry Canada RSS-Gen Issue 2 / RSS 210 Issue 7
FCC Part 15 Subpart C
on the
Summit Data Communications Inc.
Transmitter
802.11abg Compact Flash Card model SDC-MCF10AG*

UPN: 6616A-SDCMCF10AG
FCC ID: TWG-SDCMCF10AG

GRANTEE: Summit Data Communications Inc.
526 South Main St, Suite 805
Akron, OH 44311

TEST SITE(S): Elliott Laboratories
684 W. Maude Ave
Sunnyvale, CA 94086
IC Site Registration #: IC 2845-1

REPORT DATE: March 26, 2009

FINAL TEST DATE: February 23, February 24, February 25,
February 27, March 3, March 4
and March 5, 2009

AUTHORIZED SIGNATORY:



Mark E. Hill
Staff Engineer



Testing Cert #2016-01

Elliott Laboratories is accredited by the A2LA, certificate number 2016-01, to perform the test(s) listed in this report. This report shall not be reproduced, except in its entirety, without the written approval of Elliott Laboratories

REVISION HISTORY

Rev #	Date	Comments	Modified By
1	May 13, 2009	First Release	-

TABLE OF CONTENTS

COVER PAGE.....1
REVISION HISTORY2
TABLE OF CONTENTS3
SCOPE.....5
OBJECTIVE5
STATEMENT OF COMPLIANCE.....6
TEST RESULTS SUMMARY7
 DIGITAL TRANSMISSION SYSTEMS (2400 – 2483.5MHZ)7
 DIGITAL TRANSMISSION SYSTEMS (5725 –5850 MHZ)8
 GENERAL REQUIREMENTS APPLICABLE TO ALL BANDS8
MEASUREMENT UNCERTAINTIES.....9
EQUIPMENT UNDER TEST (EUT) DETAILS.....9
 GENERAL.....9
 ANTENNA SYSTEM10
 ENCLOSURE.....10
 MODIFICATIONS.....10
 SUPPORT EQUIPMENT10
 EUT INTERFACE PORTS10
 EUT OPERATION10
TEST SITE.....11
 GENERAL INFORMATION.....11
 CONDUCTED EMISSIONS CONSIDERATIONS11
 RADIATED EMISSIONS CONSIDERATIONS11
MEASUREMENT INSTRUMENTATION12
 RECEIVER SYSTEM12
 INSTRUMENT CONTROL COMPUTER12
 LINE IMPEDANCE STABILIZATION NETWORK (LISN).....12
 FILTERS/ATTENUATORS13
 ANTENNAS.....13
 ANTENNA MAST AND EQUIPMENT TURNTABLE13
 INSTRUMENT CALIBRATION.....13

TABLE OF CONTENTS (Continued)

TEST PROCEDURES14

- EUT AND CABLE PLACEMENT 14
- CONDUCTED EMISSIONS 14
- RADIATED EMISSIONS 14
- RADIATED EMISSIONS 15
- BANDWIDTH MEASUREMENTS 16
- SPECIFICATION LIMITS AND SAMPLE CALCULATIONS 17
- GENERAL TRANSMITTER RADIATED EMISSIONS SPECIFICATION LIMITS 17
- RECEIVER RADIATED SPURIOUS EMISSIONS SPECIFICATION LIMITS 18
- OUTPUT POWER LIMITS – DIGITAL TRANSMISSION SYSTEMS 18
- TRANSMIT MODE SPURIOUS RADIATED EMISSIONS LIMITS – FHSS AND DTS SYSTEMS 18
- SAMPLE CALCULATIONS - CONDUCTED EMISSIONS 19
- SAMPLE CALCULATIONS - RADIATED EMISSIONS 19
- SAMPLE CALCULATIONS - FIELD STRENGTH TO EIRP CONVERSION 20
- EXHIBIT 1: Test Equipment Calibration Data 1*
- EXHIBIT 2: Test Measurement Data 2*
- EXHIBIT 3: Photographs of Test Configurations 3*
- EXHIBIT 4: Proposed FCC ID Label & Label Location 4*
- EXHIBIT 5: Detailed Photographs 5*
- EXHIBIT 6: Operator's Manual 6*
- EXHIBIT 7: Block Diagram 7*
- EXHIBIT 8: Schematic Diagrams 8*
- EXHIBIT 9: Theory of Operation 9*
- EXHIBIT 10: RF Exposure Information 10*

SCOPE

An electromagnetic emissions test has been performed on the Summit Data Communications Inc. 802.11abg Compact Flash Card model SDC-MCF10AG pursuant to the following rules:

Industry Canada RSS-Gen Issue 2
RSS 210 Issue 7 "Low-power Licence-exempt Radiocommunication Devices (All Frequency Bands): Category I Equipment"
FCC Part 15 Subpart C

Conducted and radiated emissions data has been collected, reduced, and analyzed within this report in accordance with measurement guidelines set forth in the following reference standards and as outlined in Elliott Laboratories test procedures:

ANSI C63.4:2003
FCC DTS Measurement Procedure KDB558074, March 2005

The intentional radiator above has been tested in a simulated typical installation to demonstrate compliance with the relevant Industry Canada performance and procedural standards.

Final system data was gathered in a mode that tended to maximize emissions by varying orientation of EUT, orientation of power and I/O cabling, antenna search height, and antenna polarization.

Every practical effort was made to perform an impartial test using appropriate test equipment of known calibration. All pertinent factors have been applied to reach the determination of compliance.

The test results recorded herein are based on a single type test of the Summit Data Communications Inc. 802.11abg Compact Flash Card model SDC-MCF10AG and therefore apply only to the tested sample. The sample was selected and prepared by Jerry Pohmurski of Summit Data Communications Inc.

OBJECTIVE

The primary objective of the manufacturer is compliance with the regulations outlined in the previous section.

Prior to marketing in the USA, all unlicensed transmitters and transceivers require certification. Receive-only devices operating between 30 MHz and 960 MHz are subject to either certification or a manufacturer's declaration of conformity, with all other receive-only devices exempt from the technical requirements.

Prior to marketing in Canada, Class I transmitters, receivers and transceivers require certification. Class II devices are required to meet the appropriate technical requirements but are exempt from certification requirements.

Certification is a procedure where the manufacturer submits test data and technical information to a certification body and receives a certificate or grant of equipment authorization upon successful completion of the certification body's review of the submitted documents. Once the equipment authorization has been obtained, the label indicating compliance must be attached to all identical units, which are subsequently manufactured.

Maintenance of compliance is the responsibility of the manufacturer. Any modification of the product which may result in increased emissions should be checked to ensure compliance has been maintained (i.e., printed circuit board layout changes, different line filter, different power supply, harnessing or I/O cable changes, etc.).

STATEMENT OF COMPLIANCE

The tested sample of Summit Data Communications Inc. 802.11abg Compact Flash Card model SDC-MCF10AG complied with the requirements of the following regulations:

Industry Canada RSS-Gen Issue 2
RSS 210 Issue 7 "Low-power Licence-exempt Radiocommunication Devices (All Frequency Bands): Category I Equipment"
FCC Part 15 Subpart C

Maintenance of compliance is the responsibility of the manufacturer. Any modification of the product which may result in increased emissions should be checked to ensure compliance has been maintained (i.e., printed circuit board layout changes, different line filter, different power supply, harnessing or I/O cable changes, etc.).

TEST RESULTS SUMMARY**DIGITAL TRANSMISSION SYSTEMS (2400 – 2483.5MHz)**

FCC Rule Part	RSS Rule Part	Description	Measured Value / Comments	Limit / Requirement	Result
15.247(a)	RSS 210 A8.2	Digital Modulation	Systems uses OFDM / DSSS techniques	System must utilize a digital transmission technology	Complies
15.247 (a) (2)	RSS 210 A8.2 (1)	6dB Bandwidth	10.2 MHz – 802.11b 16.5 MHz – 802.11g	>500kHz	Complies
	RSP100	99% Bandwidth	13.3 MHz – 802.11b 17.5 MHz – 802.11g	Information only	Complies
15.247 (b) (3)	RSS 210 A8.2 (4)	Output Power (multipoint systems)	17.9 dBm(61.5mW) 802.11b EIRP = 0.148 W ^{Note 1}	1Watt, EIRP limited to 4 Watts.	Complies
15.247 (b) (3)	RSS 210 A8.2 (4)	Output Power (multipoint systems)	13.5 dBm(22.4mW) 802.11g EIRP = 0.054 W ^{Note 1}	1Watt, EIRP limited to 4 Watts.	Complies
15.247(d)	RSS 210 A8.2 (2)	Power Spectral Density	7.8 dBm/3kHz – 802.11b -13.5 dBm/3kHz – 802.11g	8dBm/3kHz	Complies
15.247(c)	RSS 210 A8.5	Antenna Port Spurious Emissions 30MHz – 25 GHz	All emissions below the -30dBc limit	< -30dBc ^{Note 2}	Complies
15.247(c) / 15.209	RSS 210 A8.5	Radiated Spurious Emissions 30MHz – 25 GHz	49.3dB μ V/m @ 4924.1MHz (-4.7dB)	15.207 in restricted bands, all others <-30dBc ^{Note 2}	Complies

Note 1: EIRP calculated using antenna gain of 3.8 dBi for the highest EIRP multi-point system.

Note 2: Limit of -30dBc used because the power was measured using the UNII test procedure (maximum power averaged over a transmission burst) / RMS averaging over a time interval, as permitted under RSS 210 section A8.4(4).

DIGITAL TRANSMISSION SYSTEMS (5725 -5850 MHz)

FCC Rule Part	RSS Rule Part	Description	Measured Value / Comments	Limit / Requirement	Result
15.247(a)	RSS 210 A8.2	Digital Modulation	Systems uses OFDM / DSSS techniques	System must utilize a digital transmission technology	Complies
15.247 (a) (2)	RSS 210 A8.2 (1)	6dB Bandwidth	16.5 MHz	>500kHz	Complies
	RSP100	99% Bandwidth	17.5 MHz	Information only	Complies
15.247 (b)	RSS 210 A8.2 (4)	Output Power (multipoint systems)	11.6dBm (14.5mW) EIRP = 0.046 W ^{Note 1}	1Watt, EIRP limited to 4 Watts.	Complies
15.247(d)	RSS 210 A8.2 (2)	Power Spectral Density	-6.2 dBm/3kHz	Maximum permitted is 8dBm/3kHz	Complies
15.247(c)	RSS 210 A8.5	Antenna Port Spurious Emissions – 30MHz – 40 GHz	All spurious emissions < -20dBc	< -30dBc ^{Note 2}	Complies
15.247(c) / 15.209	RSS 210 A8.5 Table 2, 3	Radiated Spurious Emissions 30MHz – 40 GHz	53.7dBμV/m @ 11490.3MHz (-0.3dB)	15.207 in restricted bands, all others <-30dBc ^{Note 2}	Complies

Note 1: EIRP calculated using antenna gain of 5 dBi () for the highest EIRP multi-point system.

Note 2: Limit of -30dBc used because the power was measured using the UNII test procedure (maximum power averaged over a transmission burst).

GENERAL REQUIREMENTS APPLICABLE TO ALL BANDS

FCC Rule Part	RSS Rule part	Description	Measured Value / Comments	Limit / Requirement	Result (margin)
15.203	-	RF Connector	The EUT uses a u.FL connector.		Complies
15.109	RSS GEN 7.2.3 Table 1	Receiver spurious emissions	45.0dBμV/m (177.8μV/m) @ 17353.5MHz (-9.0dB)	Refer to standard	Complies
15.207	RSS GEN Table 2	AC Conducted Emissions	31.1dBμV @ 0.810MHz (-14.9dB)	Refer to standard	Complies
15.247 (b) (5) 15.407 (f)	RSS 102	RF Exposure Requirements	Refer to MPE calculations in Exhibit 11, RSS 102 declaration and User Manual statements.	Refer to OET 65, FCC Part 1 and RSS 102	Complies
	RSP 100 RSS GEN 7.1.5	User Manual		Statement required regarding non-interference	
	RSP 100 RSS GEN 7.1.5	User Manual		Statement required regarding detachable antenna	

MEASUREMENT UNCERTAINTIES

ISO/IEC 17025 requires that an estimate of the measurement uncertainties associated with the emissions test results be included in the report. The measurement uncertainties given below are based on a 95% confidence level and were calculated in accordance with UKAS document LAB 34.

Measurement Type	Frequency Range (MHz)	Calculated Uncertainty (dB)
Conducted Emissions	0.15 to 30	± 2.4
Radiated Emissions	0.015 to 30	± 3.0
Radiated Emissions	30 to 1000	± 3.6
Radiated Emissions	1000 to 40000	± 6.0

EQUIPMENT UNDER TEST (EUT) DETAILS**GENERAL**

The Summit Data Communications Inc. 802.11abg Compact Flash Card model SDC-MCF10AG is a 802.11ag compliant wireless LAN radio Module which is designed to provide wireless local area networking connectivity. Normally, the EUT would be embedded in various types of mobile and stationary computing devices such as handheld and vehicle mounted data terminals during operation. The EUT was, therefore, placed in this position during emissions testing to simulate the end user environment. The electrical rating of the EUT is 3.3 VDC \pm 5%. It's typical power consumption is 400mA (1320mW) while in transmit mode, 180mA (594mW) while in receive mode and 10mA (33mW) while in standby mode.

The sample was received on February 23, 2009 and tested on February 23, February 24, February 25, February 27, March 3, March 4 and March 5, 2009. The EUT consisted of the following component(s):

Manufacturer	Model	Description	Serial Number
Summit Data Communications Inc.	MCF10AG	802.11AG Mini Compact Flash Module with antenna connectors	

ANTENNA SYSTEM

The antenna connects to the EUT via a standard u.fl antenna connector, thereby meeting the requirements of FCC 15.203.

There were two antennas included in the testing:

Laird Centurion, m/n NanoBlade, pcb antenna, 3.8dBi @ 2.45GHz, 5.1dBi @ 5.25GHz, 4.5dBi @ 5.8GHz

Larson, p/n R380.500.314, Omni, 1.6dBi @ 2.4GHz, 5dBi @ 5GHz

ENCLOSURE

The EUT does not have an enclosure as it is designed to be installed within the enclosure of a system.

MODIFICATIONS

The EUT did not require modifications during testing in order to comply with emissions specifications.

SUPPORT EQUIPMENT

The following equipment was used as local support equipment for emissions testing:

Manufacturer	Model	Description	Serial Number	FCC ID
Hewlett Packard	iPAQ	Handheld Computer	-	-

EUT INTERFACE PORTS

The I/O cabling configuration during emissions testing was as follows:

Port	Connected To	Cable(s)		
		Description	Shielded or Unshielded	Length(m)
iPAQ Power	AC Mains	2wire	Unshielded	1.5
Flash Module	iPAQ Module Port	-	-	-

EUT OPERATION

During emissions testing the EUT was configured to transmit at the Low, Middle, and High Channel. Testing performed at 1Mbps for 802.11b mode, and 6Mbps for 802.11g and 802.11a modes.

TEST SITE**GENERAL INFORMATION**

Final test measurements were taken on February 23, February 24, February 25, February 27, March 3, March 4 and March 5, 2009 at the test sites listed below. Pursuant to section 2.948 of the FCC's Rules and section 3.3 of RSP-100, construction, calibration, and equipment data has been filed with the Commission and with industry Canada.

Site	Registration Numbers		Location
	FCC	Canada	
SVOATS #1	90592	IC 2845A-1	684 West Maude Ave, Sunnyvale CA 94085-3518

ANSI C63.4:2003 recommends that ambient noise at the test site be at least 6 dB below the allowable limits. Ambient levels are below this requirement with the exception, on OATS sites, of predictable local TV, radio, and mobile communications traffic. The test site(s) contain separate areas for radiated and conducted emissions testing. Considerable engineering effort has been expended to ensure that the facilities conform to all pertinent requirements of ANSI C63.4:2003.

CONDUCTED EMISSIONS CONSIDERATIONS

Conducted emissions testing is performed in conformance with ANSI C63.4:2003. Measurements are made with the EUT connected to the public power network through a nominal, standardized RF impedance, which is provided by a line impedance stabilization network, known as a LISN. A LISN is inserted in series with each current-carrying conductor in the EUT power cord.

RADIATED EMISSIONS CONSIDERATIONS

The FCC has determined that radiation measurements made in a shielded enclosure are not suitable for determining levels of radiated emissions. Radiated measurements are performed in an open field environment or in a semi-anechoic chamber. The test sites are maintained free of conductive objects within the CISPR defined elliptical area incorporated in ANSI C63.4:2003 guidelines and meet the Normalized Site Attenuation (NSA) requirements of ANSI C63.4:2003.

MEASUREMENT INSTRUMENTATION

RECEIVER SYSTEM

An EMI receiver as specified in CISPR 16-1 is used for emissions measurements. The receivers used can measure over the frequency range of 9 kHz up to 2000 MHz. These receivers allow both ease of measurement and high accuracy to be achieved. The receivers have Peak, Average, and CISPR (Quasi-peak) detectors built into their design so no external adapters are necessary. The receiver automatically sets the required bandwidth for the CISPR detector used during measurements. If the repetition frequency of the signal being measured is below 20Hz, peak measurements are made in lieu of Quasi-Peak measurements.

For measurements above the frequency range of the receivers, a spectrum analyzer is utilized because it provides visibility of the entire spectrum along with the precision and versatility required to support engineering analysis. Average measurements above 1000MHz are performed on the spectrum analyzer using the linear-average method with a resolution bandwidth of 1 MHz and a video bandwidth of 10 Hz, unless the signal is pulsed in which case the average (or video) bandwidth of the measuring instrument is reduced to onset of pulse desensitization and then increased.

INSTRUMENT CONTROL COMPUTER

The receivers utilize either a Rohde & Schwarz EZM Spectrum Monitor/Controller or contain an internal Spectrum Monitor/Controller to view and convert the receiver measurements to the field strength at an antenna or voltage developed at the LISN measurement port, which is then compared directly with the appropriate specification limit. This provides faster, more accurate readings by performing the conversions described under Sample Calculations within the Test Procedures section of this report. Results are printed in a graphic and/or tabular format, as appropriate. A personal computer is used to record all measurements made with the receivers.

The Spectrum Monitor provides a visual display of the signal being measured. In addition, the controller or a personal computer run automated data collection programs which control the receivers. This provides added accuracy since all site correction factors, such as cable loss and antenna factors are added automatically.

LINE IMPEDANCE STABILIZATION NETWORK (LISN)

Line conducted measurements utilize a fifty microhenry Line Impedance Stabilization Network as the monitoring point. The LISN used also contains a 250 uH CISPR adapter. This network provides for calibrated radio frequency noise measurements by the design of the internal low pass and high pass filters on the EUT and measurement ports, respectively.

FILTERS/ATTENUATORS

External filters and precision attenuators are often connected between the receiving antenna or LISN and the receiver. This eliminates saturation effects and non-linear operation due to high amplitude transient events.

ANTENNAS

A loop antenna is used below 30 MHz. For the measurement range 30 MHz to 1000 MHz either a combination of a biconical antenna and a log periodic or a bi-log antenna is used. Above 1000 MHz, horn antennas are used. The antenna calibration factors to convert the received voltage to an electric field strength are included with appropriate cable loss and amplifier gain factors to determine an overall site factor, which is then programmed into the test receivers or incorporated into the test software.

ANTENNA MAST AND EQUIPMENT TURNTABLE

The antennas used to measure the radiated electric field strength are mounted on a non-conductive antenna mast equipped with a motor-drive to vary the antenna height. Measurements below 30 MHz are made with the loop antenna at a fixed height of 1m above the ground plane.

ANSI C63.4:2003 specifies that the test height above ground for table mounted devices shall be 80 centimeters. Floor mounted equipment shall be placed on the ground plane if the device is normally used on a conductive floor or separated from the ground plane by insulating material from 3 to 12 mm if the device is normally used on a non-conductive floor. During radiated measurements, the EUT is positioned on a motorized turntable in conformance with this requirement.

INSTRUMENT CALIBRATION

All test equipment is regularly checked to ensure that performance is maintained in accordance with the manufacturer's specifications. All antennas are calibrated at regular intervals with respect to tuned half-wave dipoles. An exhibit of this report contains the list of test equipment used and calibration information.

TEST PROCEDURES

EUT AND CABLE PLACEMENT

The regulations require that interconnecting cables be connected to the available ports of the unit and that the placement of the unit and the attached cables simulate the worst case orientation that can be expected from a typical installation, so far as practicable. To this end, the position of the unit and associated cabling is varied within the guidelines of ANSI C63.4:2003, and the worst-case orientation is used for final measurements.

CONDUCTED EMISSIONS

Conducted emissions are measured at the plug end of the power cord supplied with the EUT. Excess power cord length is wrapped in a bundle between 30 and 40 centimeters in length near the center of the cord. Preliminary measurements are made to determine the highest amplitude emission relative to the specification limit for all the modes of operation. Placement of system components and varying of cable positions are performed in each mode. A final peak mode scan is then performed in the position and mode for which the highest emission was noted on all current carrying conductors of the power cord.

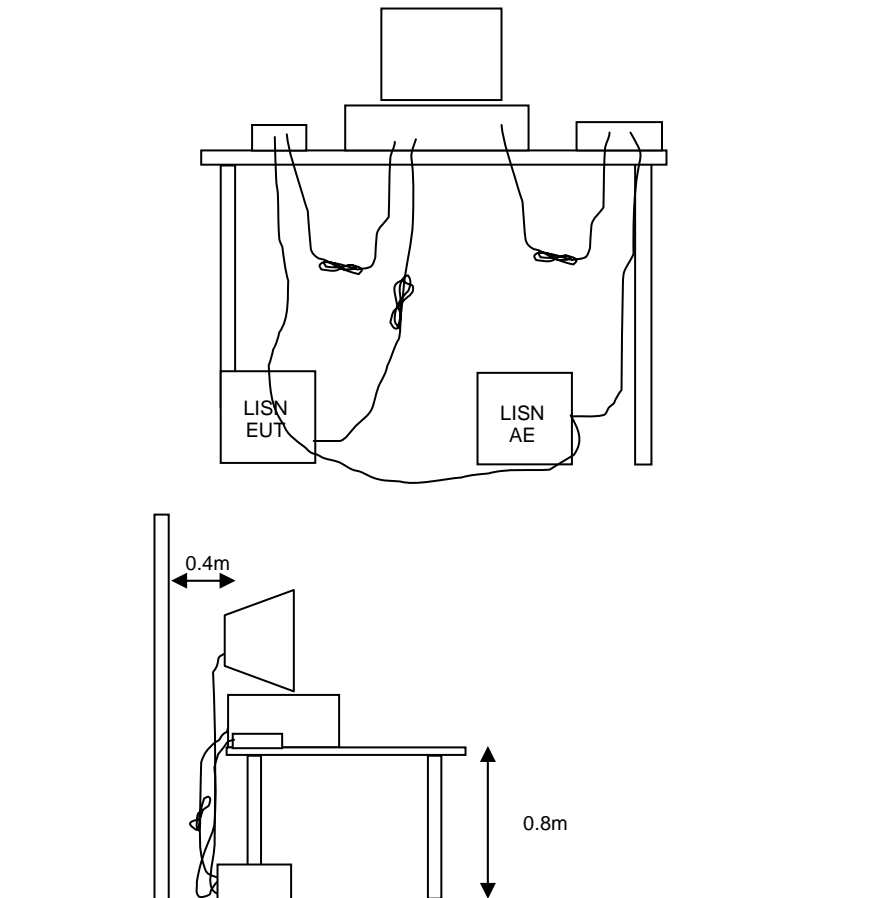

RADIATED EMISSIONS

A preliminary scan of the radiated emissions is performed in which all significant EUT frequencies are identified with the system in a nominal configuration. At least two scans are performed, one scan for each antenna polarization (horizontal and vertical; loop parallel and perpendicular to the EUT). During the preliminary scans, the EUT is rotated through 360°, the antenna height is varied (for measurements above 30 MHz) and cable positions are varied to determine the highest emission relative to the limit. Preliminary scans may be performed in a fully anechoic chamber for the purposes of identifying the frequencies of the highest emissions from the EUT.

A speaker is provided in the receiver to aid in discriminating between EUT and ambient emissions. Other methods used during the preliminary scan for EUT emissions involve scanning with near field magnetic loops, monitoring I/O cables with RF current clamps, and cycling power to the EUT.

Final maximization is a phase in which the highest amplitude emissions identified in the spectral search are viewed while the EUT azimuth angle is varied from 0 to 360 degrees relative to the receiving antenna. The azimuth, which results in the highest emission is then maintained while varying the antenna height from one to four meters (for measurements above 30 MHz, measurements below 30 MHz are made with the loop antenna at a fixed height of 1m). The result is the identification of the highest amplitude for each of the highest peaks. Each recorded level is corrected in the receiver using appropriate factors for cables, connectors, antennas, and preamplifier gain.

When testing above 18 GHz, the receive antenna is located at 1 meter from the EUT and the antenna height is restricted to a maximum of 2.5 meters.

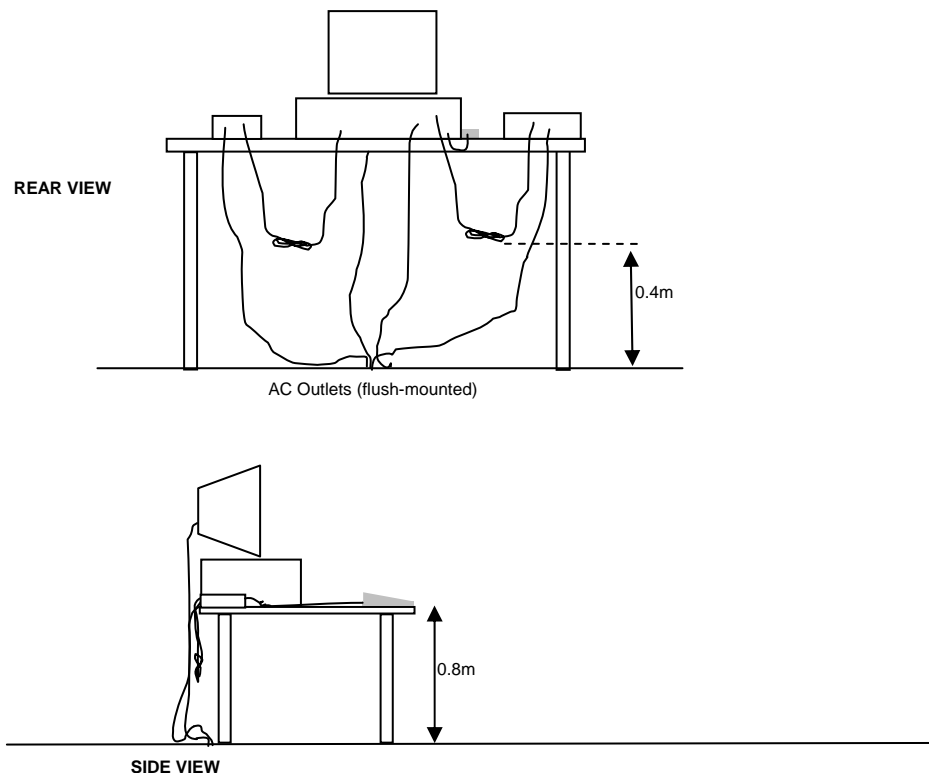

Typical Test Configuration for Radiated Field Strength Measurements

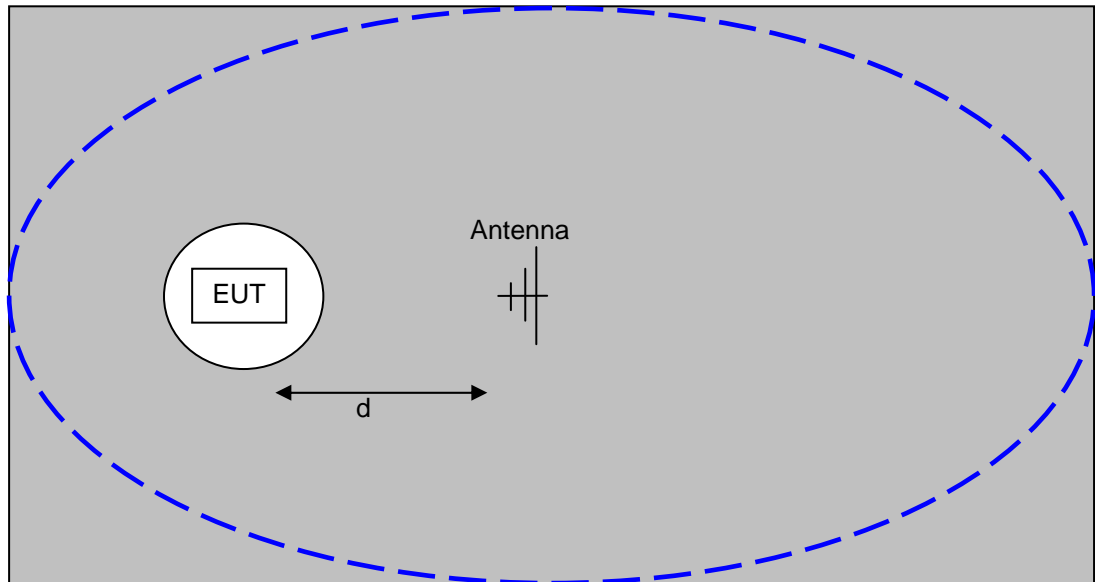

The ground plane extends beyond the ellipse defined in CISPR 16 / CISPR 22 / ANSI C63.4 and is large enough to accommodate test distances (d) of 3m and 10m. Refer to the test data tables for the actual measurement distance.

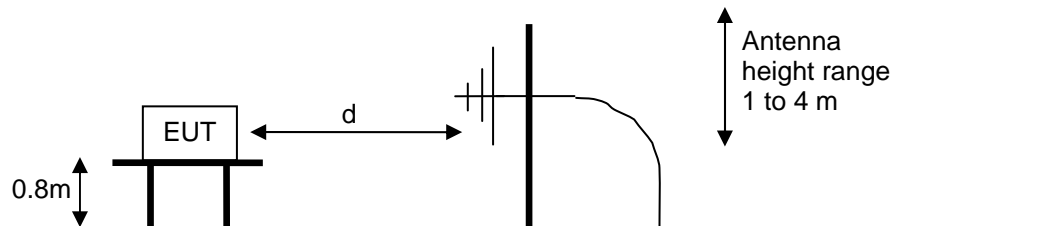

Test Configuration for Radiated Field Strength Measurements
OATS- Plan and Side Views

BANDWIDTH MEASUREMENTS

The 6dB, 20dB and/or 26dB signal bandwidth is measured in using the bandwidths recommended by ANSI C63.4. When required, the 99% bandwidth is measured using the methods detailed in RSS GEN.

SPECIFICATION LIMITS AND SAMPLE CALCULATIONS

The limits for conducted emissions are given in units of microvolts, and the limits for radiated emissions are given in units of microvolts per meter at a specified test distance. Data is measured in the logarithmic form of decibels relative to one microvolt, or dB microvolts (dBuV). For radiated emissions, the measured data is converted to the field strength at the antenna in dB microvolts per meter (dBuV/m). The results are then converted to the linear forms of uV and uV/m for comparison to published specifications.

For reference, converting the specification limits from linear to decibel form is accomplished by taking the base ten logarithm, then multiplying by 20. These limits in both linear and logarithmic form are as follows:

GENERAL TRANSMITTER RADIATED EMISSIONS SPECIFICATION LIMITS

The table below shows the limits for the spurious emissions from transmitters that fall in restricted bands¹ (with the exception of transmitters operating under FCC Part 15 Subpart D and RSS 210 Annex 9), the limits for all emissions from a low power device operating under the general rules of RSS 310 (tables 3 and 4), RSS 210 (table 2) and FCC Part 15 Subpart C section 15.209.

Frequency Range (MHz)	Limit (uV/m)	Limit (dBuV/m @ 3m)
0.009-0.490	$2400/F_{\text{KHz}} @ 300\text{m}$	$67.6-20*\log_{10}(F_{\text{KHz}}) @ 300\text{m}$
0.490-1.705	$24000/F_{\text{KHz}} @ 30\text{m}$	$87.6-20*\log_{10}(F_{\text{KHz}}) @ 30\text{m}$
1.705 to 30	30 @ 30m	29.5 @ 30m
30 to 88	100 @ 3m	40 @ 3m
88 to 216	150 @ 3m	43.5 @ 3m
216 to 960	200 @ 3m	46.0 @ 3m
Above 960	500 @ 3m	54.0 @ 3m

¹ The restricted bands are detailed in FCC 15.203, RSS 210 Table 1 and RSS 310 Table 2

RECEIVER RADIATED SPURIOUS EMISSIONS SPECIFICATION LIMITS

The table below shows the limits for the spurious emissions from receivers as detailed in FCC Part 15.109, RSS 210 Table 2, RSS GEN Table 1 and RSS 310 Table 3. Note that receivers operating outside of the frequency range 30 MHz – 960 MHz are exempt from the requirements of 15.109.

Frequency Range (MHz)	Limit (uV/m @ 3m)	Limit (dBuV/m @ 3m)
30 to 88	100	40
88 to 216	150	43.5
216 to 960	200	46.0
Above 960	500	54.0

OUTPUT POWER LIMITS – DIGITAL TRANSMISSION SYSTEMS

The table below shows the limits for output power and output power density. Where the signal bandwidth is less than 20 MHz the maximum output power is reduced to the power spectral density limit plus 10 times the log of the bandwidth (in MHz).

Operating Frequency (MHz)	Output Power	Power Spectral Density
902 – 928	1 Watt (30 dBm)	8 dBm/3kHz
2400 – 2483.5	1 Watt (30 dBm)	8 dBm/3kHz
5725 – 5850	1 Watt (30 dBm)	8 dBm/3kHz

The maximum permitted output power is reduced by 1dB for every dB the antenna gain exceeds 6dBi. Fixed point-to-point applications using the 5725 – 5850 MHz band are not subject to this restriction.

TRANSMIT MODE SPURIOUS RADIATED EMISSIONS LIMITS – FHSS and DTS SYSTEMS

The limits for unwanted (spurious) emissions from the transmitter falling in the restricted bands are those specified in the general limits sections of FCC Part 15 and RSS 210. All other unwanted (spurious) emissions shall be at least 20dB below the level of the highest in-band signal level (30dB if the power is measured using the sample detector/power averaging method).

SAMPLE CALCULATIONS - CONDUCTED EMISSIONS

Receiver readings are compared directly to the conducted emissions specification limit (decibel form) as follows:

$$R_r - S = M$$

where:

R_r = Receiver Reading in dBuV

S = Specification Limit in dBuV

M = Margin to Specification in +/- dB

SAMPLE CALCULATIONS - RADIATED EMISSIONS

Receiver readings are compared directly to the specification limit (decibel form). The receiver internally corrects for cable loss, preamplifier gain, and antenna factor. The calculations are in the reverse direction of the actual signal flow, thus cable loss is added and the amplifier gain is subtracted. The Antenna Factor converts the voltage at the antenna coaxial connector to the field strength at the antenna elements.

A distance factor, when used for electric field measurements above 30MHz, is calculated by using the following formula:

$$F_d = 20 * \text{LOG}_{10} (D_m/D_s)$$

where:

F_d = Distance Factor in dB

D_m = Measurement Distance in meters

D_s = Specification Distance in meters

For electric field measurements below 30MHz the extrapolation factor is either determined by making measurements at multiple distances or a theoretical value is calculated using the formula:

$$F_d = 40 * \text{LOG}_{10} (D_m/D_s)$$

Measurement Distance is the distance at which the measurements were taken and Specification Distance is the distance at which the specification limits are based. The antenna factor converts the voltage at the antenna coaxial connector to the field strength at the antenna elements.

The margin of a given emission peak relative to the limit is calculated as follows:

$$R_c = R_r + F_d$$

and

$$M = R_c - L_s$$

where:

$$R_r = \text{Receiver Reading in dBuV/m}$$

$$F_d = \text{Distance Factor in dB}$$

$$R_c = \text{Corrected Reading in dBuV/m}$$

$$L_s = \text{Specification Limit in dBuV/m}$$

$$M = \text{Margin in dB Relative to Spec}$$

SAMPLE CALCULATIONS - FIELD STRENGTH TO EIRP CONVERSION

Where the radiated electric field strength is expressed in terms of the equivalent isotropic radiated power (eirp), or where a field strength measurement of output power is made in lieu of a direct measurement, the following formula is used to convert between eirp and field strength at a distance of 3m from the equipment under test:

$$E = \frac{1000000 \sqrt{30 P}}{3} \quad \text{microvolts per meter}$$

where P is the eirp (Watts)

EXHIBIT 1: Test Equipment Calibration Data

2 Pages

Radiated Emissions, 1000 - 26,500 MHz, 24-Feb-09**Engineer: Rafael Varelas**

<u>Manufacturer</u>	<u>Description</u>	<u>Model #</u>	<u>Asset #</u>	<u>Cal Due</u>
Hewlett Packard	Microwave Preamp, 1-26.5GHz	8449B	785	06-Jun-09
EMCO	Antenna, Horn, 1-18 GHz (SA40-Red)	3115	1142	15-Jul-10
Hewlett Packard	SpecAn 30 Hz -40 GHz, SV (SA40) Red	8564E (84125C)	1148	24-Mar-09
Hewlett Packard	High Pass filter, 3.5 GHz (Red System)	P/N 84300-80038 (84125C)	1403	28-Aug-09

Radiated Emissions- Rx, 1000 - 18,000 MHz, 25-Feb-09**Engineer: Joseph Cadigal**

<u>Manufacturer</u>	<u>Description</u>	<u>Model #</u>	<u>Asset #</u>	<u>Cal Due</u>
EMCO	Antenna, Horn, 1-18 GHz	3115	786	06-Dec-09
Hewlett Packard	Microwave Preamp, 1-26.5GHz	8449B	870	09-Oct-09
Hewlett Packard	SpecAn 30 Hz -40 GHz, SV (SA40) Red	8564E (84125C)	1148	24-Mar-09

Radio Spurious Emissions, 27-Feb-09**Engineer: Suhaila Khushzad**

<u>Manufacturer</u>	<u>Description</u>	<u>Model #</u>	<u>Asset #</u>	<u>Cal Due</u>
Hewlett Packard	Microwave Preamp, 1-26.5GHz	8449B	870	09-Oct-09
EMCO	Antenna, Horn, 1-18 GHz (SA40-Red)	3115	1142	15-Jul-10
Hewlett Packard	SpecAn 30 Hz -40 GHz, SV (SA40) Red	8564E (84125C)	1148	24-Mar-09

Radiated Emissions, 30 - 40,000 MHz, 03-Mar-09**Engineer: Mehran Birgani**

<u>Manufacturer</u>	<u>Description</u>	<u>Model #</u>	<u>Asset #</u>	<u>Cal Due</u>
Hewlett Packard	Microwave Preamp, 1-26.5GHz	8449B	870	09-Oct-09
EMCO	Antenna, Horn, 1-18 GHz (SA40-Red)	3115	1142	15-Jul-10
Hewlett Packard	SpecAn 30 Hz -40 GHz, SV (SA40) Red	8564E (84125C)	1148	24-Mar-09
Hewlett Packard	High Pass filter, 8.2 GHz (Red System)	P/N 84300-80039 (84125C)	1152	13-Oct-09

Radiated Emissions, 1,000 - 18,000 MHz, 04-Mar-09**Engineer: Mehran Birgani**

<u>Manufacturer</u>	<u>Description</u>	<u>Model #</u>	<u>Asset #</u>	<u>Cal Due</u>
Hewlett Packard	Microwave Preamp, 1-26.5GHz	8449B	870	09-Oct-09
EMCO	Antenna, Horn, 1-18 GHz (SA40-Red)	3115	1142	15-Jul-10
Hewlett Packard	SpecAn 30 Hz -40 GHz, SV (SA40) Red	8564E (84125C)	1148	24-Mar-09

Radio Antenna Port (Power and Spurious Emissions), 05-Mar-09**Engineer: Suhaila Khushzad**

<u>Manufacturer</u>	<u>Description</u>	<u>Model #</u>	<u>Asset #</u>	<u>Cal Due</u>
Hewlett Packard	SpecAn 30 Hz -40 GHz, SV (SA40) Red	8564E (84125C)	1148	24-Mar-09

Radiated Emissions, 1000 - 26,500 MHz, 24-Feb-09

Engineer: Rafael Varelas

<u>Manufacturer</u>	<u>Description</u>	<u>Model #</u>	<u>Asset #</u>	<u>Cal Due</u>
Hewlett Packard	Microwave Preamplifier, 1-26.5GHz	8449B	785	06-Jun-09
EMCO	Antenna, Horn, 1-18 GHz (SA40-Red)	3115	1142	15-Jul-10
Hewlett Packard	SpecAn 30 Hz -40 GHz, SV (SA40) Red	8564E (84125C)	1148	24-Mar-09

Radio Antenna Port (Power and Spurious Emissions), 05-Mar-09

Engineer: Suhaila Khushzad

<u>Manufacturer</u>	<u>Description</u>	<u>Model #</u>	<u>Asset #</u>	<u>Cal Due</u>
Hewlett Packard	SpecAn 30 Hz -40 GHz, SV (SA40) Red	8564E (84125C)	1148	24-Mar-09

EXHIBIT 2: Test Measurement Data

T74640 49 Pages

T74641 32 Pages



EMC Test Data

Client:	Summit Data Communications	Job Number:	J74548
Model:	802.11abg Compact Flash Card	T-Log Number:	T74640
		Account Manager:	Christine Krebill
Contact:	Jerry Pohmurski		
Emissions Standard(s):	FCC 15.247/RSS 210	Class:	-
Immunity Standard(s):	-	Environment:	-

EMC Test Data

For The

Summit Data Communications

Model

802.11abg Compact Flash Card

Date of Last Test: 3/10/2009



EMC Test Data

Client:	Summit Data Communications	Job Number:	J74548
Model:	802.11abg Compact Flash Card	T-Log Number:	T74640
Contact:	Jerry Pohmurski	Account Manger:	Christine Krebill
Emissions Standard(s):	FCC 15.247/RSS 210	Class:	-
Immunity Standard(s):	-	Environment:	-

EUT INFORMATION

**The following information was collected during the test session(s).
The client agreed to provide the following information after the test session(s).**

General Description

The EUT is a 802.11ag compliant wireless LAN radio Module which is designed to provide wireless local area networking connectivity. Normally, the EUT would be embedded in various types of mobile and stationary computing devices such as handheld and vehicle mounted data terminals during operation. The EUT was, therefore, placed in this position during emissions testing to simulate the end user environment. The electrical rating of the EUT is 3.3 VDC \pm 5%. It's typical power consumption is 400mA (1320mW) while in transmit mode, 180mA (594mW) while in receive mode and 10mA (33mW) while in standby mode.

Equipment Under Test

Manufacturer	Model	Description	Serial Number	FCC ID
Summit Data Communications Inc.	MCF10AG	802.11AG Mini Compact Flash Module with antenna connectors		TWG-SDCMCF10AG

EUT Antenna (Intentional Radiators Only)

The antenna connects to the EUT via a standard u.f1 antenna connector, thereby meeting the requirements of FCC 15.203. There were two antennas included in the testing:
Laird Centurion, m/n NanoBlade, pcb antenna, 3.8dBi @ 2.45GHz, 5.1dBi @ 5.25GHz, 4.5dBi @ 5.8GHz
Larson, p/n R380.500.314, Omni, 1.6dBi @ 2.4GHz, 5dBi @ 5GHz

EUT Enclosure

The EUT does not have an enclosure as it is designed to be installed within the enclosure of a host computer or system.

Modification History

Mod. #	Test	Date	Modification
1			No modifications were made to the EUT during testing.
2			
3			

Modifications applied are assumed to be used on subsequent tests unless otherwise stated as a further modification.



EMC Test Data

Client:	Summit Data Communications	Job Number:	J74548
Model:	802.11abg Compact Flash Card	T-Log Number:	T74640
		Account Manger:	Christine Krebill
Contact:	Jerry Pohmurski		
Emissions Standard(s):	FCC 15.247/RSS 210	Class:	-
Immunity Standard(s):	-	Environment:	-

Test Configuration #1

The following information was collected during the test session(s).

Local Support Equipment

Manufacturer	Model	Description	Serial Number	FCC ID
Hewlett Packard	iPAQ	Handheld Computer	-	-

Remote Support Equipment

Manufacturer	Model	Description	Serial Number	FCC ID
None	-	-	-	-

Cabling and Ports

Port	Connected To	Cable(s)		
		Description	Shielded or Unshielded	Length(m)
iPAQ Power	AC Mains	2wire	Unshielded	1.5
Flash Module	iPAQ Module Port	-	-	-

EUT Operation During Emissions Tests

During emissions testing the EUT was configured to transmit at the Low, Middle, and High Channel. Testing performed at 1Mbps for 802.11b mode, and 6Mbps for 802.11g and 802.11a modes.

Client:	Summit Data Communications	Job Number:	J74548
Model:	802.11abg Compact Flash Card	T-Log Number:	T74640
		Account Manager:	Christine Krebill
Contact:	Jerry Pohmurski		
Standard:	FCC 15.247/RSS 210	Class:	N/A

RSS 210 and FCC 15.247 (DTS) Radiated Spurious Emissions (PCB Antenna)

Test Specific Details

Objective: The objective of this test session is to perform final qualification testing of the EUT with respect to the specification listed above.

General Test Configuration

The EUT and all local support equipment were located on the turntable for radiated spurious emissions testing.

For radiated emissions testing the measurement antenna was located 3 meters from the EUT.

Summary of Results - Device Operating in the 2400-2483.5 MHz Band

NOTE: A preliminary check of output power was performed. The port with the highest power was used for the final testing. Preliminary tests showed no radio related emissions below 1 GHz.

Run #	Mode	Channel	Power Setting	Port	Test Performed	Limit	Result / Margin
1a	b mode	low	100%	Aux	Restricted Band Edge (2390 MHz)	FCC Part 15.209 / 15.247(c)	47.0dB μ V/m @ 2389.6MHz (-7.0dB)
			100%	Aux	Radiated Emissions, 1 - 26 GHz	FCC Part 15.209 / 15.247(c)	46.6dB μ V/m @ 4824.1MHz (-7.4dB)
1b	b mode	center	100%	Aux	Radiated Emissions, 1 - 26 GHz	FCC Part 15.209 / 15.247(c)	47.2dB μ V/m @ 4874.1MHz (-6.8dB)
1c	b mode	high	100%	Aux	Restricted Band Edge (2483.5 MHz)	FCC Part 15.209 / 15.247(c)	48.0dB μ V/m @ 2483.6MHz (-6.0dB)
			100%	Aux	Radiated Emissions, 1 - 26 GHz	FCC Part 15.209 / 15.247(c)	46.5dB μ V/m @ 4924.1MHz (-7.5dB)
2a	g mode	low	100%	Aux	Restricted Band Edge (2390 MHz)	FCC Part 15.209 / 15.247(c)	48.5dB μ V/m @ 2389.9MHz (-5.5dB)
			100%	Aux	Radiated Emissions, 1 - 26 GHz	FCC Part 15.209 / 15.247(c)	35.0dB μ V/m @ 7251.4MHz (-19.0dB)
2b	g mode	center	100%	Aux	Radiated Emissions, 1 - 26 GHz	FCC Part 15.209 / 15.247(c)	35.2dB μ V/m @ 7331.9MHz (-18.8dB)
2c	g mode	high	100%	Aux	Restricted Band Edge (2483.5 MHz)	FCC Part 15.209 / 15.247(c)	48.0dB μ V/m @ 2483.5MHz (-6.0dB)
			100%	Aux	Radiated Emissions, 1 - 26 GHz	FCC Part 15.209 / 15.247(c)	38.7dB μ V/m @ 4924.1MHz (-15.3dB)

Client:	Summit Data Communications	Job Number:	J74548
Model:	802.11abg Compact Flash Card	T-Log Number:	T74640
		Account Manager:	Christine Krebill
Contact:	Jerry Pohmurski		
Standard:	FCC 15.247/RSS 210	Class:	N/A

Run #	Mode	Channel	Power Setting	Port	Test Performed	Limit	Result / Margin
3a	a mode	low	100%	Aux	Radiated Emissions, 1 - 40GHz	FCC Part 15.209 / 15.247(c)	53.7dB μ V/m @ 11490.3MHz (-0.3dB)
3b	a mode	center	100%	Aux	Radiated Emissions, 1 - 40GHz	FCC Part 15.209 / 15.247(c)	52.1dB μ V/m @ 11570.3MHz (-1.9dB)
3c	a mode	high	100%	Aux	Radiated Emissions, 1 - 40GHz	FCC Part 15.209 / 15.247(c)	43.8dB μ V/m @ 17413.8MHz (-10.2dB)

Modifications Made During Testing

No modifications were made to the EUT during testing

Deviations From The Standard

No deviations were made from the requirements of the standard.

Client:	Summit Data Communications	Job Number:	J74548
Model:	802.11abg Compact Flash Card	T-Log Number:	T74640
		Account Manager:	Christine Krebill
Contact:	Jerry Pohmurski		
Standard:	FCC 15.247/RSS 210	Class:	N/A

Run #1: Radiated Spurious Emissions, 30 - 26000 MHz. Operating Mode: 802.11b

Date of Test: 2/23/2009
Test Engineer: Suhaila Khushzad
Test Location: OATS #1

Config. Used: 1
Config Change: None
Host Unit Voltage 120V/60Hz

Ambient Conditions: Temperature: 15.6 °C
Rel. Humidity: 80 %

Run #1a: Low Channel @ 2412 MHz**Fundamental Signal Field Strength:** Peak and average values measured in 1 MHz, and peak value measured in 100kHz

Frequency	Level	Pol	15.209 / 15.247		Detector	Azimuth	Height	Comments
MHz	dB μ V/m	V/H	Limit	Margin	Pk/QP/Avg	degrees	meters	
2409.670	102.4	H	-	-	AVG	88	2.1	RB 1 MHz; VB: 10 Hz
2415.150	103.5	H	-	-	PK	88	2.1	RB 1 MHz; VB: 1 MHz
2415.010	101.5	V	-	-	AVG	307	1.0	RB 1 MHz; VB: 10 Hz
2413.360	104.0	V	-	-	PK	307	1.0	RB 1 MHz; VB: 1 MHz
2414.270	99.1	V	-	-	PK	307	1.0	RB 100 kHz; VB: 100 kHz
2414.360	98.9	H	-	-	PK	88	2.1	RB 100 kHz; VB: 100 kHz

Fundamental emission level @ 3m in 100kHz RBW:	99.1 dB μ V/m
--	-------------------

Limit for emissions outside of restricted bands:	69.1 dB μ V/m	Limit is -30dBc (UNII power measurement)
--	-------------------	--

Band Edge Signal Field Strength

Frequency	Level	Pol	15.209 / 15.247		Detector	Azimuth	Height	Comments
MHz	dB μ V/m	V/H	Limit	Margin	Pk/QP/Avg	degrees	meters	
2389.600	47.0	V	54.0	-7.0	AVG	307	1.0	RB 1 MHz; VB: 10 Hz
2380.130	58.4	V	74.0	-15.6	PK	307	1.0	RB 1 MHz; VB: 1 MHz
2389.800	46.9	H	54.0	-7.1	AVG	88	2.1	RB 1 MHz; VB: 10 Hz
2357.870	57.9	H	74.0	-16.1	PK	88	2.1	RB 1 MHz; VB: 1 MHz

Note 1: Calculated by subtracting the marker delta values from the fundamental field strength measurements.

Client:	Summit Data Communications	Job Number:	J74548
Model:	802.11abg Compact Flash Card	T-Log Number:	T74640
		Account Manager:	Christine Krebill
Contact:	Jerry Pohmurski		
Standard:	FCC 15.247/RSS 210	Class:	N/A

Other Spurious Emissions

Frequency MHz	Level dB μ V/m	Pol V/H	15.209 / 15.247		Detector Pk/QP/Avg	Azimuth degrees	Height meters	Comments
			Limit	Margin				
4824.090	46.6	V	54.0	-7.4	AVG	63	1.0	RB 1 MHz; VB: 10 Hz
4824.150	42.4	H	54.0	-11.6	AVG	233	1.1	RB 1 MHz; VB: 10 Hz
12061.390	40.4	V	54.0	-13.6	AVG	310	1.0	RB 1 MHz; VB: 10 Hz
12061.240	40.4	H	54.0	-13.6	AVG	0	1.0	RB 1 MHz; VB: 10 Hz
12060.380	51.9	V	74.0	-22.1	PK	310	1.0	RB 1 MHz; VB: 1 MHz
12061.070	51.9	H	74.0	-22.1	PK	0	1.0	RB 1 MHz; VB: 1 MHz
9647.970	50.1	V	74.0	-23.9	PK	108	1.0	RB 1 MHz; VB: 1 MHz
9646.500	50.0	H	74.0	-24.0	PK	360	1.0	RB 1 MHz; VB: 1 MHz
4823.990	49.7	V	74.0	-24.3	PK	63	1.0	RB 1 MHz; VB: 1 MHz
7236.330	47.7	H	74.0	-26.3	PK	0	1.0	RB 1 MHz; VB: 1 MHz
7235.320	47.5	V	74.0	-26.5	PK	248	1.0	RB 1 MHz; VB: 1 MHz
4823.950	47.4	H	74.0	-26.6	PK	233	1.1	RB 1 MHz; VB: 1 MHz
9649.370	39.0	H	74.0	-35.0	AVG	360	1.0	RB 1 MHz; VB: 10 Hz
9647.930	38.9	V	74.0	-35.1	AVG	108	1.0	RB 1 MHz; VB: 10 Hz
7236.920	36.4	V	74.0	-37.6	AVG	248	1.0	RB 1 MHz; VB: 10 Hz
7237.480	36.1	H	74.0	-37.9	AVG	0	1.0	RB 1 MHz; VB: 10 Hz

Note 1: For emissions in restricted bands, the limit of 15.209 was used. For all other emissions, the limit was set 30dB below the level of the fundamental and measured in 100kHz.

Client:	Summit Data Communications	Job Number:	J74548
Model:	802.11abg Compact Flash Card	T-Log Number:	T74640
Contact:	Jerry Pohmurski	Account Manager:	Christine Krebill
Standard:	FCC 15.247/RSS 210	Class:	N/A

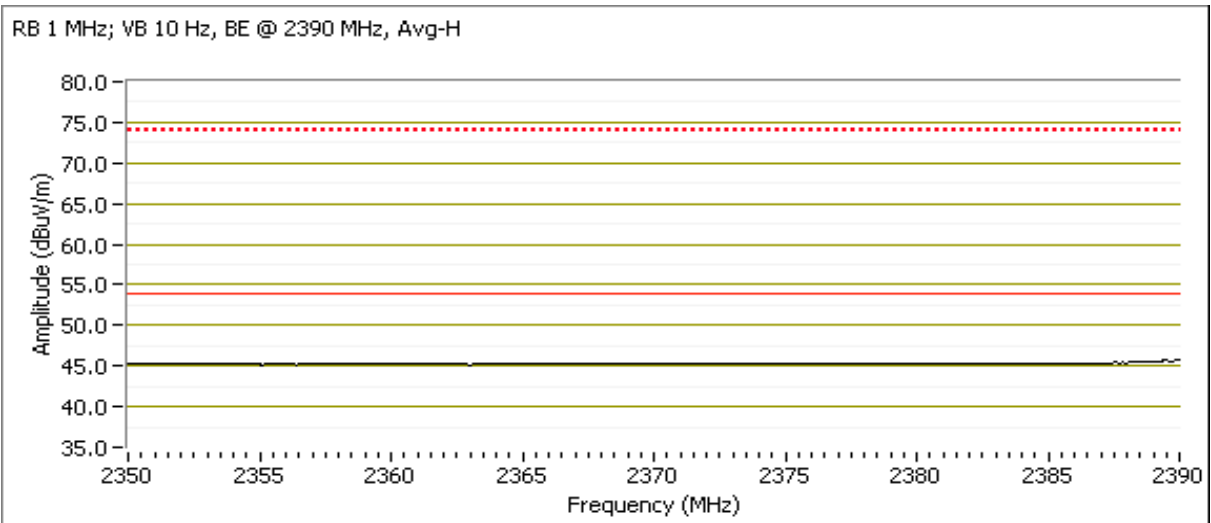
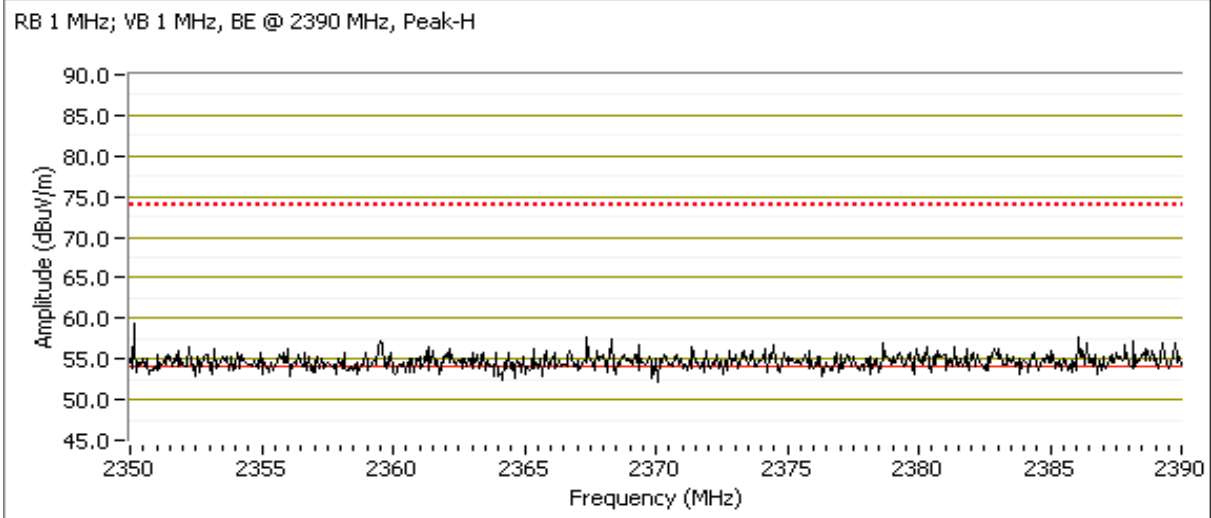

Client:	Summit Data Communications	Job Number:	J74548
Model:	802.11abg Compact Flash Card	T-Log Number:	T74640
Contact:	Jerry Pohmurski	Account Manager:	Christine Krebill
Standard:	FCC 15.247/RSS 210	Class:	N/A

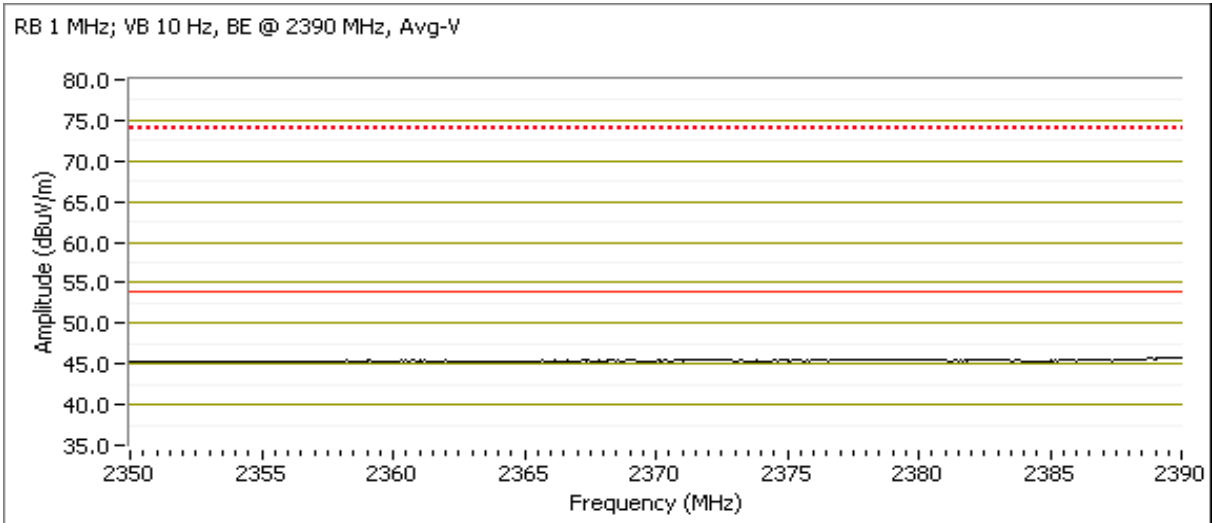
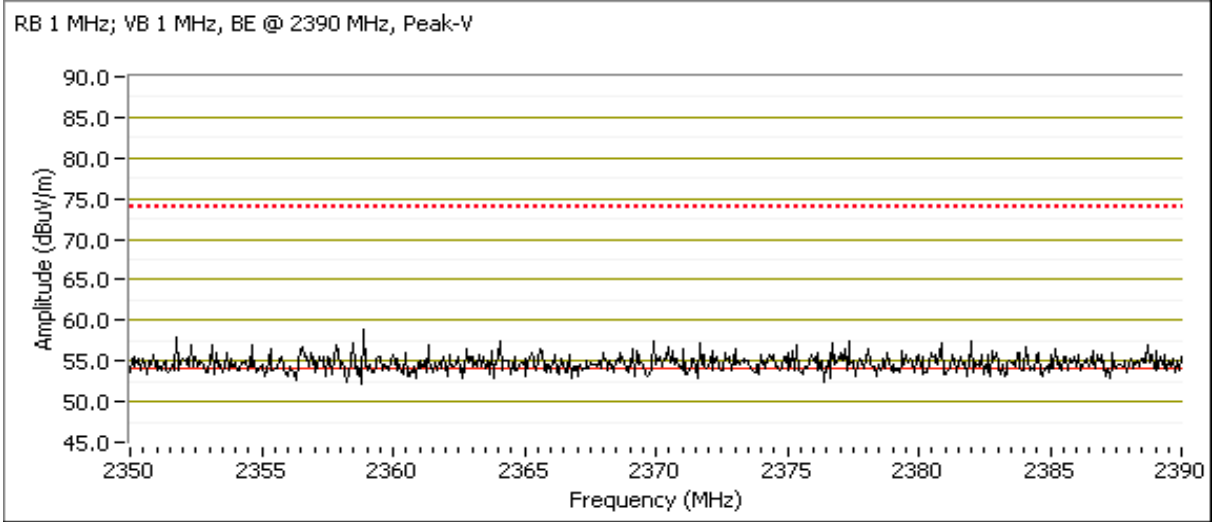

Client:	Summit Data Communications	Job Number:	J74548
Model:	802.11abg Compact Flash Card	T-Log Number:	T74640
Contact:	Jerry Pohmurski	Account Manager:	Christine Krebill
Standard:	FCC 15.247/RSS 210	Class:	N/A

Run #1b: Center Channel @ 2437 MHz

Frequency MHz	Level dB μ V/m	Pol V/H	15.209 / 15.247		Detector Pk/QP/Avg	Azimuth degrees	Height meters	Comments
			Limit	Margin				
4874.050	47.2	V	54.0	-6.8	AVG	311	1.9	RB 1 MHz; VB: 10 Hz
4874.100	42.8	H	54.0	-11.2	AVG	242	1.6	RB 1 MHz; VB: 10 Hz
12186.430	40.8	V	54.0	-13.2	AVG	83	1.0	RB 1 MHz; VB: 10 Hz
12186.110	40.7	H	54.0	-13.3	AVG	207	1.0	RB 1 MHz; VB: 10 Hz
7311.510	35.9	H	54.0	-18.1	AVG	184	1.0	RB 1 MHz; VB: 10 Hz
7312.060	35.9	V	54.0	-18.1	AVG	360	1.0	RB 1 MHz; VB: 10 Hz
12185.460	51.6	H	74.0	-22.4	PK	207	1.0	RB 1 MHz; VB: 1 MHz
12186.140	51.6	V	74.0	-22.4	PK	83	1.0	RB 1 MHz; VB: 1 MHz
4873.960	50.4	V	74.0	-23.6	PK	311	1.9	RB 1 MHz; VB: 1 MHz
9747.850	50.4	V	74.0	-23.6	PK	0	1.0	RB 1 MHz; VB: 1 MHz
9747.970	50.2	H	74.0	-23.8	PK	199	1.0	RB 1 MHz; VB: 1 MHz
4874.030	48.3	H	74.0	-25.7	PK	242	1.6	RB 1 MHz; VB: 1 MHz
7309.580	47.1	H	74.0	-26.9	PK	184	1.0	RB 1 MHz; VB: 1 MHz
7311.430	46.9	V	74.0	-27.1	PK	360	1.0	RB 1 MHz; VB: 1 MHz
9748.170	39.1	V	74.0	-34.9	AVG	0	1.0	RB 1 MHz; VB: 10 Hz
9747.840	39.0	H	74.0	-35.0	AVG	199	1.0	RB 1 MHz; VB: 10 Hz

Note 1: For emissions in restricted bands, the limit of 15.209 was used. For all other emissions, the limit was set 30dB below the level of the fundamental and measured in 100kHz.

Client:	Summit Data Communications	Job Number:	J74548
Model:	802.11abg Compact Flash Card	T-Log Number:	T74640
		Account Manager:	Christine Krebill
Contact:	Jerry Pohmurski		
Standard:	FCC 15.247/RSS 210	Class:	N/A

Run #1c: High Channel @ 2462 MHz

Fundamental Signal Field Strength: Peak and average values measured in 1 MHz, and peak value measured in 100kHz

Frequency MHz	Level dB μ V/m	Pol V/H	15.209 / 15.247		Detector Pk/QP/Avg	Azimuth degrees	Height meters	Comments
			Limit	Margin				
2459.640	101.5	V	-	-	AVG	226	1.0	RB 1 MHz; VB: 10 Hz
2459.920	104.2	V	-	-	PK	226	1.0	RB 1 MHz; VB: 1 MHz
2459.560	99.8	H	-	-	AVG	283	1.0	RB 1 MHz; VB: 10 Hz
2459.850	102.1	H	-	-	PK	283	1.0	RB 1 MHz; VB: 1 MHz
2459.350	99.6	V	-	-	PK	226	1.0	RB 100 kHz; VB: 100 kHz
2465.370	87.3	H	-	-	PK	293	1.0	RB 100 kHz; VB: 100 kHz

Fundamental emission level @ 3m in 100kHz RBW: 99.6 dB μ V/m

Limit for emissions outside of restricted bands: 69.6 dB μ V/m Limit is -30dBc (UNII power measurement)

Band Edge Signal Field Strength

Frequency MHz	Level dB μ V/m	Pol V/H	15.209 / 15.247		Detector Pk/QP/Avg	Azimuth degrees	Height meters	Comments
			Limit	Margin				
2483.580	48.0	V	54.0	-6.0	AVG	226	1.0	RB 1 MHz; VB: 10 Hz
2496.860	58.7	V	74.0	-15.3	PK	226	1.0	RB 1 MHz; VB: 1 MHz
2483.580	47.0	H	54.0	-7.0	AVG	293	1.0	RB 1 MHz; VB: 10 Hz
2499.150	58.0	H	74.0	-16.0	PK	293	1.0	RB 1 MHz; VB: 1 MHz

Other Spurious Emissions

Frequency MHz	Level dB μ V/m	Pol V/H	15.209 / 15.247		Detector Pk/QP/Avg	Azimuth degrees	Height meters	Comments
			Limit	Margin				
4924.080	46.5	V	54.0	-7.5	AVG	34	1.1	RB 1 MHz; VB: 10 Hz
4924.080	46.2	H	54.0	-7.8	AVG	230	1.0	RB 1 MHz; VB: 10 Hz
12311.130	40.6	H	54.0	-13.4	AVG	0	1.0	RB 1 MHz; VB: 10 Hz
12311.460	40.6	V	54.0	-13.4	AVG	360	1.0	RB 1 MHz; VB: 10 Hz
7386.830	35.9	H	54.0	-18.1	AVG	0	1.0	RB 1 MHz; VB: 10 Hz
7384.510	35.8	V	54.0	-18.2	AVG	360	1.0	RB 1 MHz; VB: 10 Hz
12310.610	52.2	V	74.0	-21.8	PK	360	1.0	RB 1 MHz; VB: 1 MHz
12308.930	51.3	H	74.0	-22.7	PK	0	1.0	RB 1 MHz; VB: 1 MHz
4923.990	50.6	V	74.0	-23.4	PK	34	1.1	RB 1 MHz; VB: 1 MHz
9847.580	50.6	V	74.0	-23.4	PK	0	1.0	RB 1 MHz; VB: 1 MHz
4924.100	50.2	H	74.0	-23.8	PK	230	1.0	RB 1 MHz; VB: 1 MHz
9847.210	50.0	H	74.0	-24.0	PK	360	1.0	RB 1 MHz; VB: 1 MHz
7384.720	47.1	H	74.0	-26.9	PK	0	1.0	RB 1 MHz; VB: 1 MHz
7387.240	47.1	V	74.0	-26.9	PK	360	1.0	RB 1 MHz; VB: 1 MHz
9847.780	38.6	V	74.0	-35.4	AVG	0	1.0	RB 1 MHz; VB: 10 Hz
9846.890	38.5	H	74.0	-35.5	AVG	360	1.0	RB 1 MHz; VB: 10 Hz

Note 1: For emissions in restricted bands, the limit of 15.209 was used. For all other emissions, the limit was set 30dB below the level of the fundamental and measured in 100kHz.

Client:	Summit Data Communications	Job Number:	J74548
Model:	802.11abg Compact Flash Card	T-Log Number:	T74640
Contact:	Jerry Pohmurski	Account Manager:	Christine Krebill
Standard:	FCC 15.247/RSS 210	Class:	N/A

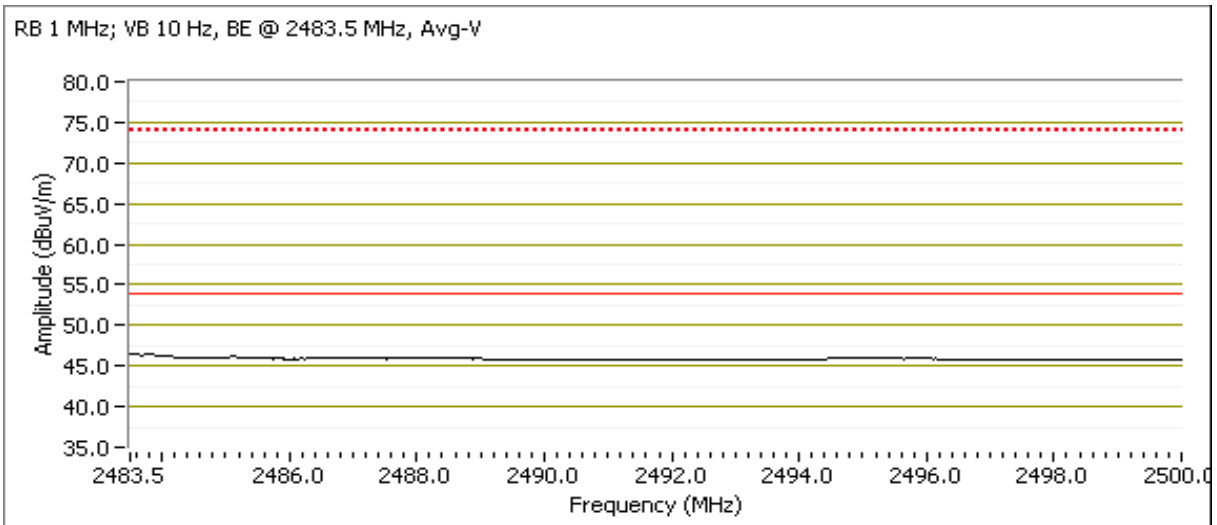
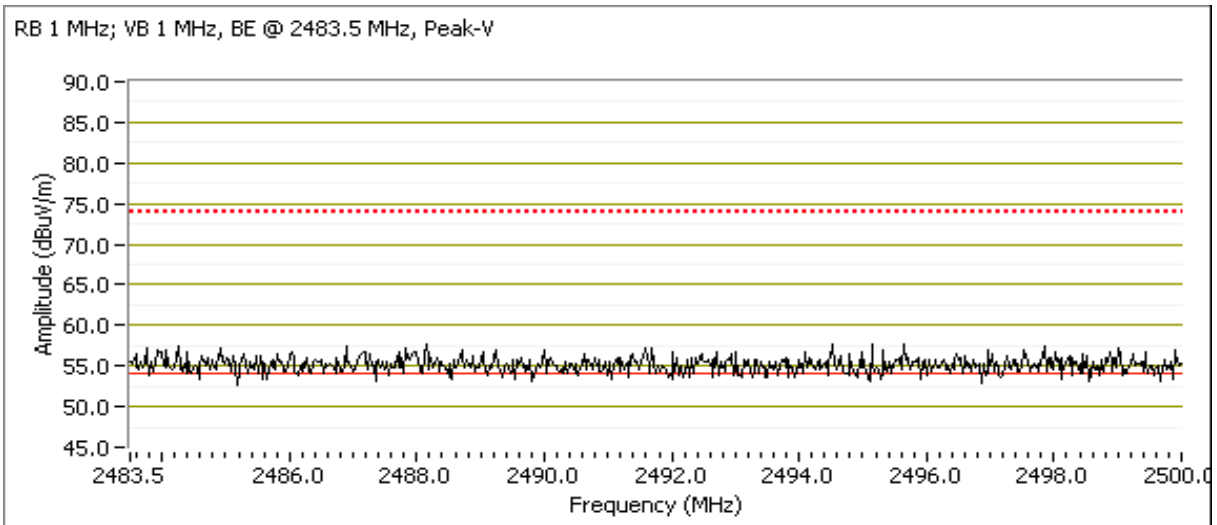

Client:	Summit Data Communications	Job Number:	J74548
Model:	802.11abg Compact Flash Card	T-Log Number:	T74640
Contact:	Jerry Pohmurski	Account Manager:	Christine Krebill
Standard:	FCC 15.247/RSS 210	Class:	N/A

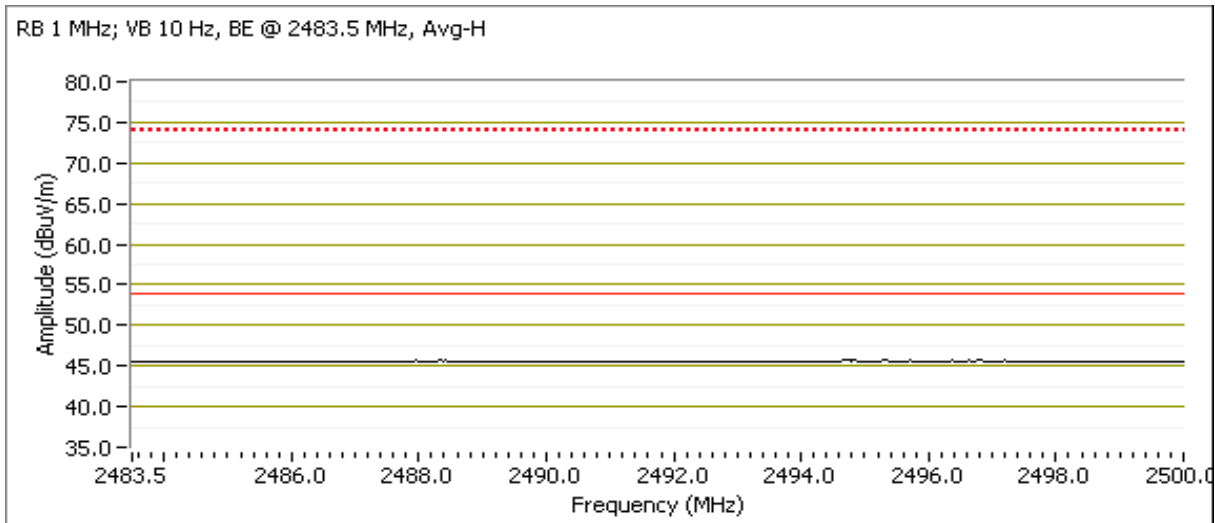
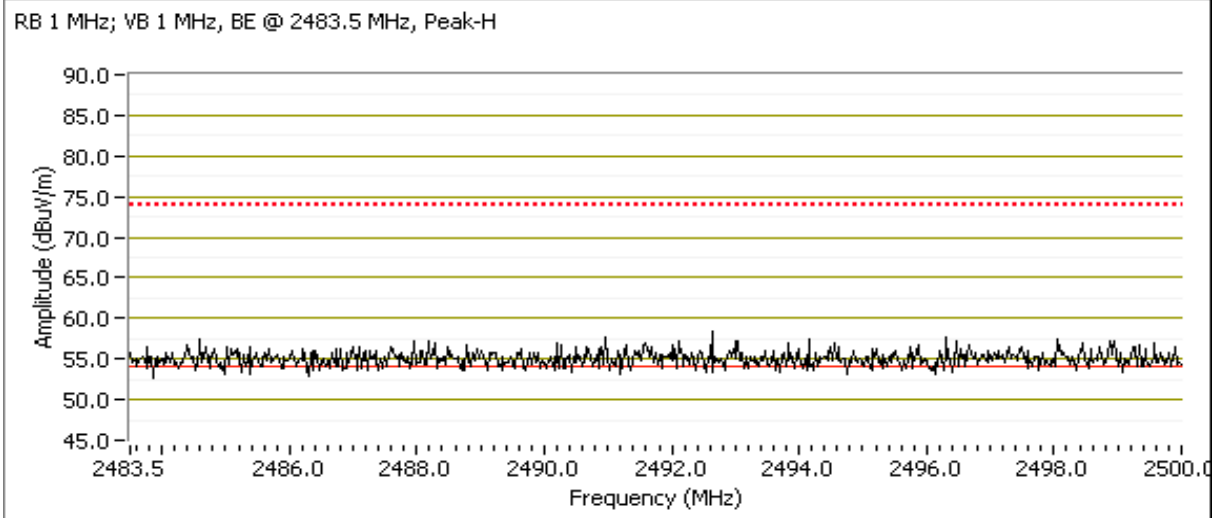

Client:	Summit Data Communications	Job Number:	J74548
Model:	802.11abg Compact Flash Card	T-Log Number:	T74640
		Account Manager:	Christine Krebill
Contact:	Jerry Pohmurski		
Standard:	FCC 15.247/RSS 210	Class:	N/A

Run #2: Radiated Spurious Emissions, 30 - 26000 MHz. Operating Mode: 802.11g
 Date of Test: 2/23/2009 Config. Used: 1
 Test Engineer: Suhaila Khushzad Config Change: None
 Test Location: OATS #1 Host Unit Voltage 120V/60Hz

Ambient Conditions: Temperature: 16 °C
 Rel. Humidity: 80 %

Run #2a: Low Channel @ 2412 MHz

Fundamental Signal Field Strength: Peak and average values measured in 1 MHz, and peak value measured in 100kHz

Frequency	Level	Pol	15.209 / 15.247		Detector	Azimuth	Height	Comments
MHz	dB μ V/m	V/H	Limit	Margin	Pk/QP/Avg	degrees	meters	
2414.260	95.1	H	-	-	AVG	259	2.1	RB 1 MHz; VB: 10 Hz
2413.910	103.7	H	-	-	PK	259	2.1	RB 1 MHz; VB: 1 MHz
2410.990	95.4	V	-	-	AVG	300	1.0	RB 1 MHz; VB: 10 Hz
2410.640	103.5	V	-	-	PK	300	1.0	RB 1 MHz; VB: 1 MHz
2417.440	94.7	H	-	-	PK	259	2.1	RB 100 kHz; VB: 100 kHz
2419.880	95.0	V	-	-	PK	300	1.0	RB 100 kHz; VB: 100 kHz

Fundamental emission level @ 3m in 100kHz RBW:	95.0 dB μ V/m	
Limit for emissions outside of restricted bands:	65.0 dB μ V/m	Limit is -30dBc (UNII power measurement)

Band Edge Signal Field Strength

Frequency	Level	Pol	15.209 / 15.247		Detector	Azimuth	Height	Comments
MHz	dB μ V/m	V/H	Limit	Margin	Pk/QP/Avg	degrees	meters	
2389.870	48.5	V	54.0	-5.5	AVG	300	1.0	RB 1 MHz; VB: 10 Hz
2387.470	60.8	V	74.0	-13.2	PK	300	1.0	RB 1 MHz; VB: 1 MHz
2390.000	47.3	H	54.0	-6.7	AVG	259	2.1	RB 1 MHz; VB: 10 Hz
2389.130	58.4	H	74.0	-15.6	PK	259	2.1	RB 1 MHz; VB: 1 MHz

Other Spurious Emissions

Frequency	Level	Pol	15.209 / 15.247		Detector	Azimuth	Height	Comments
MHz	dB μ V/m	V/H	Limit	Margin	Pk/QP/Avg	degrees	meters	
7251.410	35.0	H	54.0	-19.0	AVG	0	1.0	RB 1 MHz; VB: 10 Hz
4824.210	33.2	V	54.0	-20.8	AVG	243	1.0	RB 1 MHz; VB: 10 Hz
4824.140	32.7	H	54.0	-21.3	AVG	313	1.1	RB 1 MHz; VB: 10 Hz
9669.500	48.5	H	74.0	-25.5	PK	50	1.0	RB 1 MHz; VB: 1 MHz
7226.750	46.8	H	74.0	-27.2	PK	0	1.0	RB 1 MHz; VB: 1 MHz
7237.290	45.6	V	74.0	-28.4	PK	187	1.0	RB 1 MHz; VB: 1 MHz
4824.650	44.5	V	74.0	-29.5	PK	243	1.0	RB 1 MHz; VB: 1 MHz
4826.010	44.0	H	74.0	-30.0	PK	313	1.1	RB 1 MHz; VB: 1 MHz
9655.380	37.8	H	74.0	-36.2	AVG	50	1.0	RB 1 MHz; VB: 10 Hz
7249.900	34.9	V	74.0	-39.1	AVG	187	1.0	RB 1 MHz; VB: 10 Hz

Note 1: For emissions in restricted bands, the limit of 15.209 was used. For all other emissions, the limit was set 30dB below the level of the fundamental and measured in 100kHz.

Client:	Summit Data Communications	Job Number:	J74548
Model:	802.11abg Compact Flash Card	T-Log Number:	T74640
Contact:	Jerry Pohmurski	Account Manager:	Christine Krebill
Standard:	FCC 15.247/RSS 210	Class:	N/A

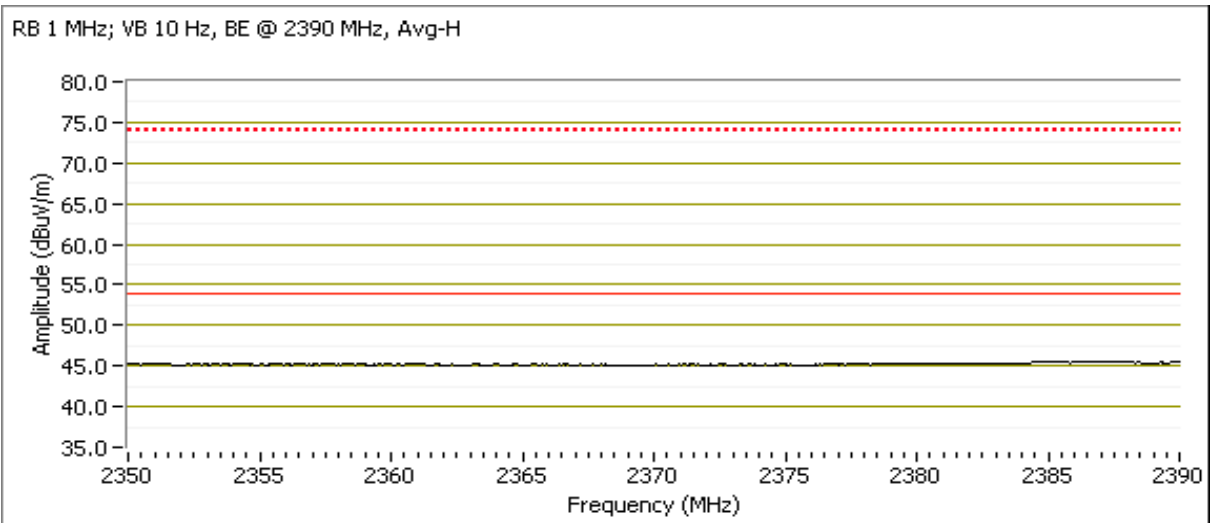
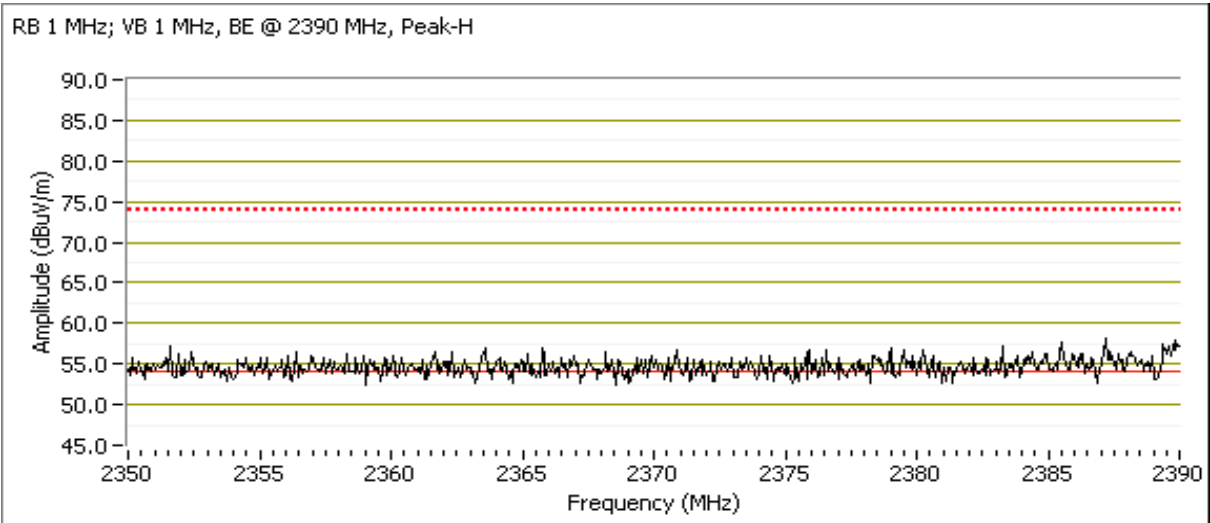

Client:	Summit Data Communications	Job Number:	J74548
Model:	802.11abg Compact Flash Card	T-Log Number:	T74640
Contact:	Jerry Pohmurski	Account Manager:	Christine Krebill
Standard:	FCC 15.247/RSS 210	Class:	N/A

RB 1 MHz; VB 1 MHz, BE @ 2390 MHz, Peak-V

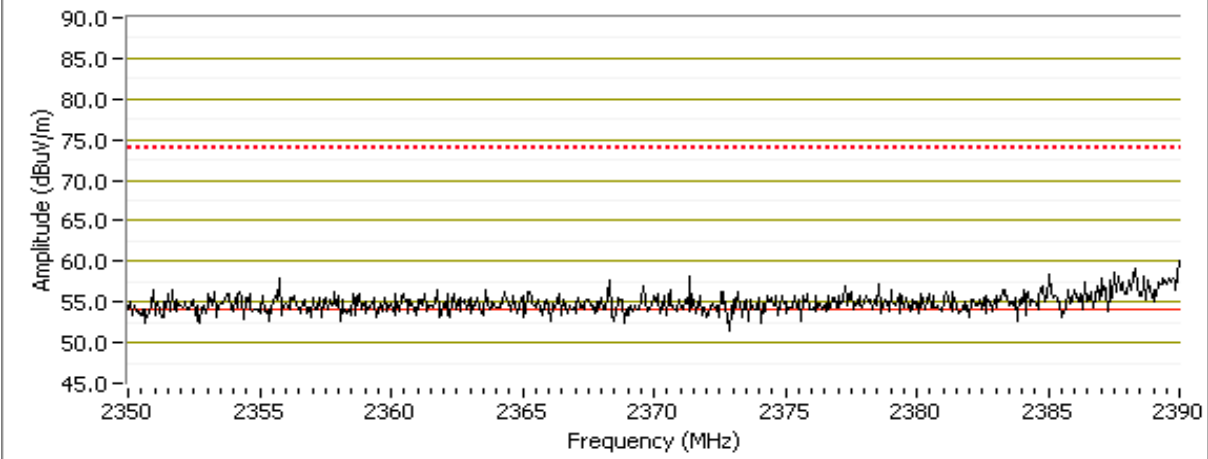

RB 1 MHz; VB 10 Hz, BE @ 2390 MHz, Avg-V

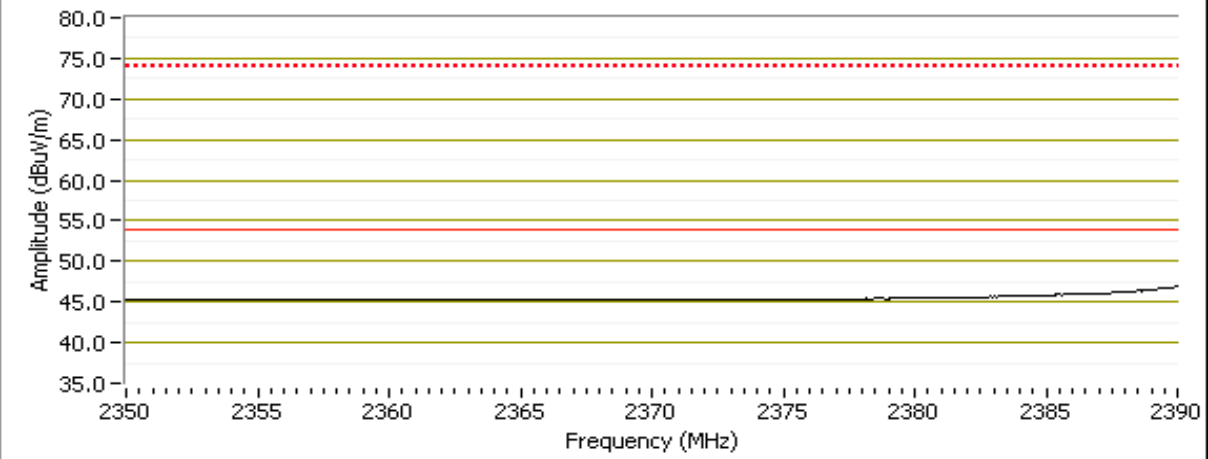

Client:	Summit Data Communications	Job Number:	J74548
Model:	802.11abg Compact Flash Card	T-Log Number:	T74640
Contact:	Jerry Pohmurski	Account Manager:	Christine Krebill
Standard:	FCC 15.247/RSS 210	Class:	N/A

Run #2b: Center Channel @ 2437 MHz

Fundamental Signal Field Strength: Peak and average values measured in 1 MHz, and peak value measured in 100kHz

Frequency MHz	Level dB μ V/m	Pol V/H	15.209 / 15.247		Detector Pk/QP/Avg	Azimuth degrees	Height meters	Comments
			Limit	Margin				
2438.860	95.7	V	-	-	AVG	202	1.0	RB 1 MHz; VB: 10 Hz
2438.720	104.0	V	-	-	PK	202	1.0	RB 1 MHz; VB: 1 MHz
2433.200	96.7	H	-	-	AVG	314	2.4	RB 1 MHz; VB: 10 Hz
2434.200	104.9	H	-	-	PK	314	2.4	RB 1 MHz; VB: 1 MHz
2439.870	95.1	V	-	-	PK	202	1.0	RB 100 kHz; VB: 100 kHz
2438.720	94.5	H	-	-	PK	314	2.4	RB 100 kHz; VB: 100 kHz

Fundamental emission level @ 3m in 100kHz RBW:	95.1 dB μ V/m	Limit is -30dBc (UNII power measurement)
Limit for emissions outside of restricted bands:	65.1 dB μ V/m	

Frequency MHz	Level dB μ V/m	Pol V/H	15.209 / 15.247		Detector Pk/QP/Avg	Azimuth degrees	Height meters	Comments
			Limit	Margin				
7331.860	35.2	H	54.0	-18.8	AVG	31	1.0	RB 1 MHz; VB: 10 Hz
7330.530	35.1	V	54.0	-18.9	AVG	46	1.0	RB 1 MHz; VB: 10 Hz
4874.170	34.8	H	54.0	-19.2	AVG	304	1.0	RB 1 MHz; VB: 10 Hz
4874.210	34.3	V	54.0	-19.7	AVG	102	1.0	RB 1 MHz; VB: 10 Hz
7327.430	46.2	H	74.0	-27.8	PK	31	1.0	RB 1 MHz; VB: 1 MHz
7323.860	45.9	V	74.0	-28.1	PK	46	1.0	RB 1 MHz; VB: 1 MHz
4874.500	45.4	H	74.0	-28.6	PK	304	1.0	RB 1 MHz; VB: 1 MHz
4871.490	45.2	V	74.0	-28.8	PK	102	1.0	RB 1 MHz; VB: 1 MHz

Note 1: For emissions in restricted bands, the limit of 15.209 was used. For all other emissions, the limit was set 30dB below the level of the fundamental and measured in 100kHz.

Client:	Summit Data Communications	Job Number:	J74548
Model:	802.11abg Compact Flash Card	T-Log Number:	T74640
Contact:	Jerry Pohmurski	Account Manager:	Christine Krebill
Standard:	FCC 15.247/RSS 210	Class:	N/A

Run #2c: High Channel @ 2462 MHz

Fundamental Signal Field Strength: Peak and average values measured in 1 MHz, and peak value measured in 100kHz

Frequency MHz	Level dB μ V/m	Pol V/H	15.209 / 15.247		Detector Pk/QP/Avg	Azimuth degrees	Height meters	Comments
			Limit	Margin				
2468.020	88.4	V	-	-	AVG	44	1.0	RB 1 MHz; VB: 10 Hz
2467.230	97.0	V	-	-	PK	44	1.0	RB 1 MHz; VB: 1 MHz
2457.700	94.0	H	-	-	AVG	101	2.1	RB 1 MHz; VB: 10 Hz
2455.050	101.7	H	-	-	PK	101	2.1	RB 1 MHz; VB: 1 MHz
2455.980	92.3	H	-	-	PK	101	2.1	RB 100 kHz; VB: 100 kHz
2469.880	86.3	V	-	-	PK	44	1.0	RB 100 kHz; VB: 100 kHz

Fundamental emission level @ 3m in 100kHz RBW:	92.3 dB μ V/m	Limit is -30dBc (UNII power measurement)
Limit for emissions outside of restricted bands:	62.3 dB μ V/m	

Band Edge Signal Field Strength

Frequency MHz	Level dB μ V/m	Pol V/H	15.209 / 15.247		Detector Pk/QP/Avg	Azimuth degrees	Height meters	Comments
			Limit	Margin				
2483.500	48.0	H	54.0	-6.0	AVG	101	2.1	
2487.320	58.5	H	74.0	-15.5	PK	101	2.1	
2483.500	47.6	V	54.0	-6.4	AVG	44	1.0	
2484.490	58.3	V	74.0	-15.7	PK	44	1.0	

Other Spurious Emissions

Frequency MHz	Level dB μ V/m	Pol V/H	15.209 / 15.247		Detector Pk/QP/Avg	Azimuth degrees	Height meters	Comments
			Limit	Margin				
4923.650	35.9	H	54.0	-18.1	AVG	263	1.0	
4924.120	38.7	V	54.0	-15.3	AVG	349	1.2	
7389.070	35.3	H	54.0	-18.7	AVG	358	1.0	Noise Floor
7389.170	35.3	V	54.0	-18.7	AVG	29	1.0	Noise Floor
4921.900	47.6	H	74.0	-26.4	PK	263	1.0	
4926.350	50.3	V	74.0	-23.7	PK	349	1.2	
7381.780	46.6	H	74.0	-27.4	PK	358	1.0	Noise Floor
7388.750	46.7	V	74.0	-27.3	PK	29	1.0	Noise Floor

Note 1: Signal is not in a restricted band but the more stringent restricted band limit was used.

Client:	Summit Data Communications	Job Number:	J74548
Model:	802.11abg Compact Flash Card	T-Log Number:	T74640
Contact:	Jerry Pohmurski	Account Manager:	Christine Krebill
Standard:	FCC 15.247/RSS 210	Class:	N/A

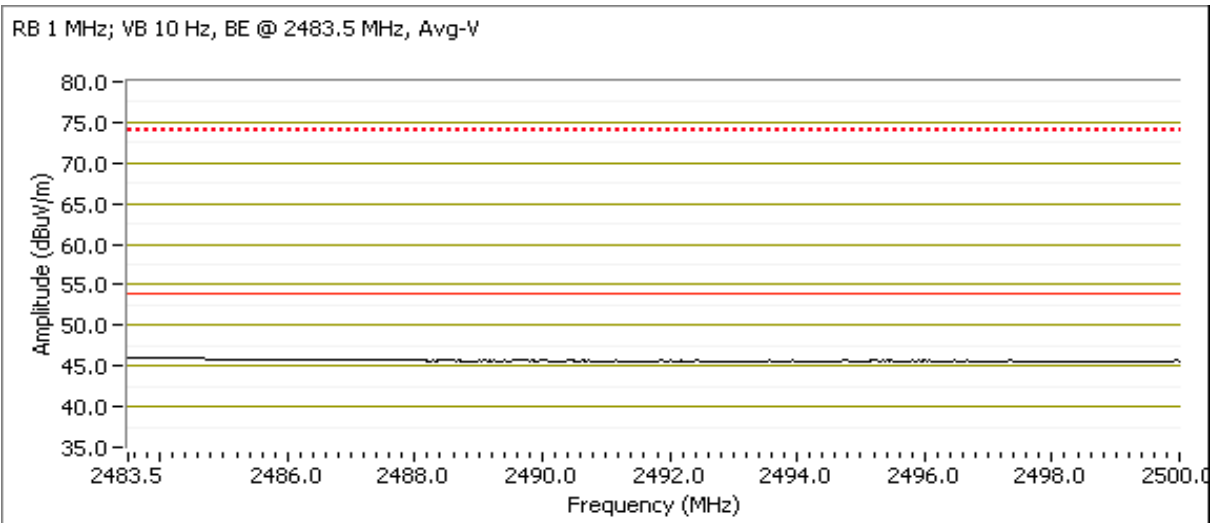
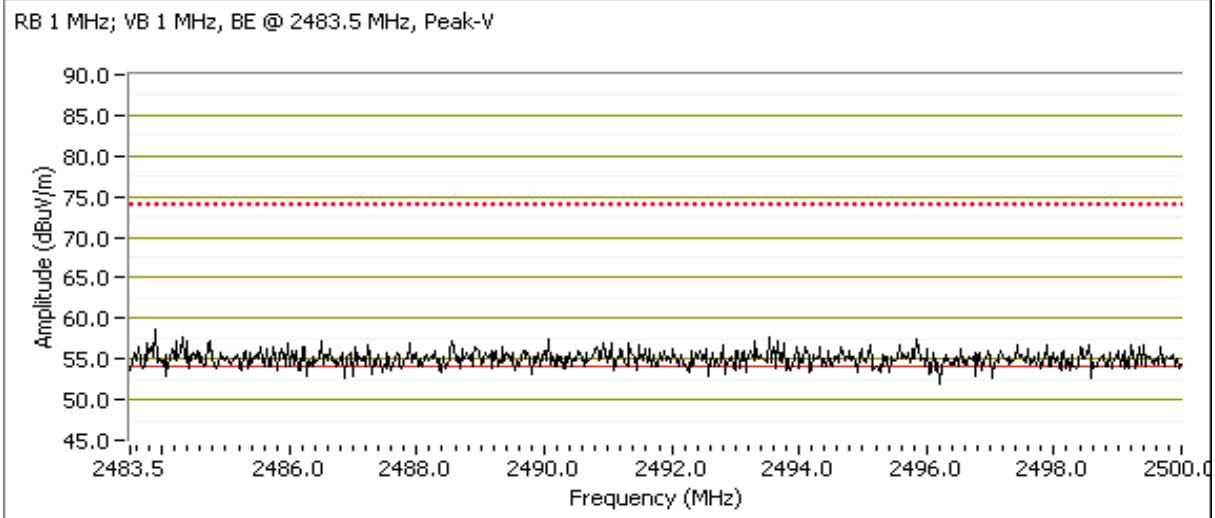

Client:	Summit Data Communications	Job Number:	J74548
Model:	802.11abg Compact Flash Card	T-Log Number:	T74640
Contact:	Jerry Pohmurski	Account Manager:	Christine Krebill
Standard:	FCC 15.247/RSS 210	Class:	N/A

RB 1 MHz; VB 1 MHz, BE @ 2483.5 MHz, Peak-H

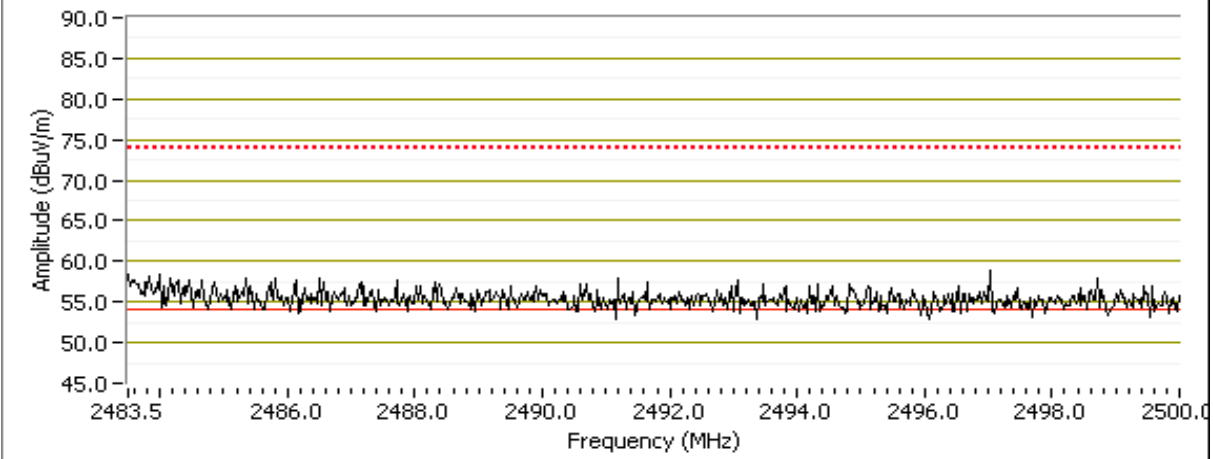

RB 1 MHz; VB 10 Hz, BE @ 2483.5 MHz, Avg-H

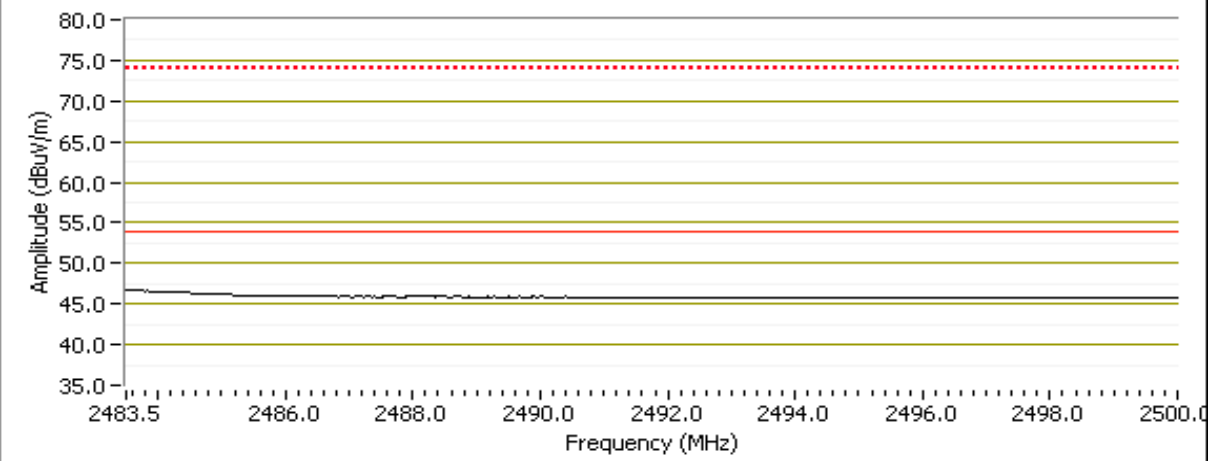

Client:	Summit Data Communications	Job Number:	J74548
Model:	802.11abg Compact Flash Card	T-Log Number:	T74640
		Account Manager:	Christine Krebill
Contact:	Jerry Pohmurski		
Standard:	FCC 15.247/RSS 210	Class:	N/A

Run #3: Radiated Spurious Emissions, 30 - 40000 MHz. Operating Mode: 802.11a

Date of Test: 3/3/2009
 Test Engineer: Mehran Birgani
 Test Location: SVOATS #1

Config. Used: 1
 Config Change: None
 Host Unit Voltage 120V/60Hz

Ambient Conditions: Temperature: 10 °C
 Rel. Humidity: 100 %

Run #3a: Low Channel @ 5745 MHz

Other Spurious Emissions

Frequency MHz	Level dB μ V/m	Pol V/H	15.209 / 15.247		Detector Pk/QP/Avg	Azimuth degrees	Height meters	Comments
			Limit	Margin				
11490.280	44.3	H	54.0	-9.7	AVG	34	1.7	
11490.300	53.7	V	54.0	-0.3	AVG	34	1.4	
17235.270	44.8	V	54.0	-9.2	AVG	226	1.0	Note 1, Noise Floor
17236.400	44.9	H	54.0	-9.1	AVG	359	2.0	Note 1, Noise Floor
11492.280	68.4	V	74.0	-5.6	PK	34	1.4	
11492.550	58.5	H	74.0	-15.5	PK	34	1.7	
17235.120	55.6	H	74.0	-18.4	PK	359	2.0	Note 1, Noise Floor
17238.570	56.5	V	74.0	-17.5	PK	226	1.0	Note 1, Noise Floor

Note 1: Signal is not in a restricted band but the more stringent restricted band limit was used.

Run #3b: Center Channel @ 5785 MHz

Other Spurious Emissions

Frequency MHz	Level dB μ V/m	Pol V/H	15.209 / 15.247		Detector Pk/QP/Avg	Azimuth degrees	Height meters	Comments
			Limit	Margin				
11570.120	44.7	H	54.0	-9.3	AVG	24	1.5	
11570.300	52.1	V	54.0	-1.9	AVG	29	1.4	
17357.870	45.4	V	54.0	-8.6	AVG	10	1.0	Note 1, Noise Floor
11564.630	57.4	H	74.0	-16.6	PK	24	1.5	
11572.570	66.5	V	74.0	-7.5	PK	29	1.4	
17355.920	56.3	V	74.0	-17.7	PK	10	1.0	Note 1, Noise Floor

Note 1: Signal is not in a restricted band but the more stringent restricted band limit was used.

Client:	Summit Data Communications	Job Number:	J74548
Model:	802.11abg Compact Flash Card	T-Log Number:	T74640
		Account Manager:	Christine Krebill
Contact:	Jerry Pohmurski		
Standard:	FCC 15.247/RSS 210	Class:	N/A

Run #3c: High Channel @ 5805 MHz (channel 161)
Other Spurious Emissions

Frequency MHz	Level dB μ V/m	Pol V/H	15.209 / 15.247		Detector Pk/QP/Avg	Azimuth degrees	Height meters	Comments
			Limit	Margin				
17413.830	43.8	V	54.0	-10.2	AVG	360	1.0	MHz; VB: 10 Hz
17414.140	43.4	H	54.0	-10.6	AVG	279	1.7	MHz; VB: 10 Hz
11609.000	36.7	H	54.0	-17.3	AVG	360	1.2	MHz; VB: 10 Hz
11608.600	36.5	H	54.0	-17.5	AVG	360	1.0	MHz; VB: 10 Hz
17414.530	56.1	V	74.0	-17.9	PK	360	1.0	MHz; VB: 1 MHz
17413.700	55.5	H	74.0	-18.5	PK	279	1.7	MHz; VB: 1 MHz
11608.510	49.1	H	74.0	-24.9	PK	360	1.0	MHz; VB: 1 MHz
11610.080	49.0	H	74.0	-25.0	PK	360	1.2	MHz; VB: 1 MHz

Note 1: Signal is not in a restricted band but the more stringent restricted band limit was used.

Client:	Summit Data Communications	Job Number:	J74548
Model:	802.11abg Compact Flash Card	T-Log Number:	T74640
		Account Manager:	Christine Krebill
Contact:	Jerry Pohmurski		
Standard:	FCC 15.247/RSS 210	Class:	N/A

RSS 210 and FCC 15.247 (DTS) Radiated Spurious Emissions (Larson Antenna)

Test Specific Details

Objective: The objective of this test session is to perform final qualification testing of the EUT with respect to the specification listed above.

General Test Configuration

The EUT and all local support equipment were located on the turntable for radiated spurious emissions testing.

For radiated emissions testing the measurement antenna was located 3 meters from the EUT.

Summary of Results - Device Operating in the 2400-2483.5 MHz Band

NOTE: A preliminary check of output power was performed. The port with the highest power was used for the final testing. Preliminary tests showed no radio related emissions below 1 GHz.

Run #	Mode	Channel	Power Setting	Port	Test Performed	Limit	Result / Margin
1a	b mode	low	100%	Aux	Restricted Band Edge (2390 MHz)	FCC Part 15.209 / 15.247 (c)	47.6dB μ V/m @ 2385.3MHz (-6.4dB)
			100%	Aux	Radiated Emissions, 1 - 26 GHz	FCC Part 15.209 / 15.247 (c)	48.6dB μ V/m @ 4824.1MHz (-5.4dB)
1b	b mode	center	100%	Aux	Radiated Emissions, 1 - 26 GHz	FCC Part 15.209 / 15.247 (c)	47.6dB μ V/m @ 4874.1MHz (-6.4dB)
1c	b mode	high	100%	Aux	Restricted Band Edge (2483.5 MHz)	FCC Part 15.209 / 15.247 (c)	48.7dB μ V/m @ 2483.5MHz (-5.3dB)
			100%	Aux	Radiated Emissions, 1 - 26 GHz	FCC Part 15.209 / 15.247 (c)	49.3dB μ V/m @ 4924.1MHz (-4.7dB)
2a	g mode	low	100%	Aux	Restricted Band Edge (2390 MHz)	FCC Part 15.209 / 15.247 (c)	48.6dB μ V/m @ 2390.0MHz (-5.4dB)
			100%	Aux	Radiated Emissions, 1 - 26 GHz	FCC Part 15.209 / 15.247 (c)	35.4dB μ V/m @ 7250.5MHz (-18.6dB)
2b	g mode	center	100%	Aux	Radiated Emissions, 1 - 26 GHz	FCC Part 15.209 / 15.247 (c)	35.7dB μ V/m @ 7332.1MHz (-18.3dB)
2c	g mode	high	100%	Aux	Restricted Band Edge (2483.5 MHz)	FCC Part 15.209 / 15.247 (c)	52.1dB μ V/m @ 2483.5MHz (-1.9dB)
			100%	Aux	Radiated Emissions, 1 - 26 GHz	FCC Part 15.209 / 15.247 (c)	35.1dB μ V/m @ 7333.6MHz (-18.9dB)

Client:	Summit Data Communications	Job Number:	J74548
Model:	802.11abg Compact Flash Card	T-Log Number:	T74640
		Account Manager:	Christine Krebill
Contact:	Jerry Pohmurski		
Standard:	FCC 15.247/RSS 210	Class:	N/A

Run #	Mode	Channel	Power Setting	Port	Test Performed	Limit	Result / Margin
3a	a mode	low	100%	Aux	Radiated Emissions, 1 - 40GHz	FCC Part 15.209 / 15.247(c)	52.2dB μ V/m @ 11492.3MHz (-1.8dB)
3b	a mode	center	100%	Aux	Radiated Emissions, 1 - 40GHz	FCC Part 15.209 / 15.247(c)	48.7dB μ V/m @ 11570.3MHz (-5.3dB)
3c	a mode	high	100%	Aux	Radiated Emissions, 1 - 40GHz	FCC Part 15.209 / 15.247(c)	45.7dB μ V/m @ 17414.3MHz (-8.3dB)

Modifications Made During Testing

No modifications were made to the EUT during testing

Deviations From The Standard

No deviations were made from the requirements of the standard.

Client:	Summit Data Communications	Job Number:	J74548
Model:	802.11abg Compact Flash Card	T-Log Number:	T74640
		Account Manager:	Christine Krebill
Contact:	Jerry Pohmurski		
Standard:	FCC 15.247/RSS 210	Class:	N/A

Run #1: Radiated Spurious Emissions, 30 - 26000 MHz. Operating Mode: 802.11b

Date of Test: 2/23/2009
Test Engineer: Suhaila Khushzad/Rafael Varelas
Test Location: OATS #1
Config. Used: 1
Config Change: None
Host Unit Voltage: 120V/60Hz

Ambient Conditions: Temperature: 16.1 °C
Rel. Humidity: 72 %

Run #1a: Low Channel @ 2412 MHz**Fundamental Signal Field Strength:** Peak and average values measured in 1 MHz, and peak value measured in 100kHz

Frequency MHz	Level dBµV/m	Pol v/h	15.209 / 15.247 Limit Margin		Detector Pk/QP/Avg	Azimuth degrees	Height meters	Comments
2409.560	92.3	H	-	-	AVG	216	1.0	RB 1 MHz; VB: 10 Hz
2409.920	94.8	H	-	-	PK	216	1.0	RB 1 MHz; VB: 1 MHz
2409.640	103.4	V	-	-	AVG	165	1.0	RB 1 MHz; VB: 10 Hz
2415.010	105.9	V	-	-	PK	165	1.0	RB 1 MHz; VB: 1 MHz
2414.440	100.4	V	-	-	PK	165	1.0	RB 100 kHz; VB: 100 kHz
2409.350	89.8	H	-	-	PK	216	1.0	RB 100 kHz; VB: 100 kHz

Fundamental emission level @ 3m in 100kHz RBW:	100.4	dBµV/m	
Limit for emissions outside of restricted bands:	80.4	dBµV/m	Limit is -20dBc (Peak power measurement)
Limit for emissions outside of restricted bands:	70.4	dBµV/m	Limit is -30dBc (UNII power measurement)

Band Edge Signal Field Strength

Frequency MHz	Level dBµV/m	Pol v/h	15.209 / 15.247 Limit Margin		Detector Pk/QP/Avg	Azimuth degrees	Height meters	Comments
2385.330	47.6	V	54.0	-6.4	AVG	165	1.0	MHz; VB: 10 Hz
2360.470	59.2	V	74.0	-14.8	PK	165	1.0	MHz; VB: 1 MHz
2354.000	46.8	H	54.0	-7.2	AVG	216	1.0	MHz; VB: 10 Hz
2376.400	57.9	H	74.0	-16.1	PK	216	1.0	MHz; VB: 1 MHz

Client:	Summit Data Communications	Job Number:	J74548
Model:	802.11abg Compact Flash Card	T-Log Number:	T74640
		Account Manager:	Christine Krebill
Contact:	Jerry Pohmurski		
Standard:	FCC 15.247/RSS 210	Class:	N/A

Other Spurious Emissions

Frequency MHz	Level dB μ V/m	Pol v/h	15.209 / 15.247		Detector Pk/QP/Avg	Azimuth degrees	Height meters	Comments
			Limit	Margin				
4824.060	48.6	V	54.0	-5.4	AVG	73	1.0	RB 1 MHz; VB: 10 Hz
4824.150	51.7	V	74.0	-22.3	PK	73	1.0	RB 1 MHz; VB: 1 MHz
7235.190	36.4	V	74.0	-37.6	AVG	279	1.0	RB 1 MHz; VB: 10 Hz
7235.440	48.1	V	74.0	-25.9	PK	279	1.0	RB 1 MHz; VB: 1 MHz
9647.990	39.4	V	74.0	-34.6	AVG	46	1.0	RB 1 MHz; VB: 10 Hz
9647.820	50.4	V	74.0	-23.6	PK	46	1.0	RB 1 MHz; VB: 1 MHz
12061.110	41.3	V	54.0	-12.7	AVG	36	2.0	RB 1 MHz; VB: 10 Hz
12058.830	52.3	V	74.0	-21.7	PK	36	2.0	RB 1 MHz; VB: 1 MHz
4824.100	43.7	H	54.0	-10.3	AVG	171	1.3	RB 1 MHz; VB: 10 Hz
4824.120	48.0	H	74.0	-26.0	PK	171	1.3	RB 1 MHz; VB: 1 MHz
7236.830	36.1	H	74.0	-37.9	AVG	231	1.0	RB 1 MHz; VB: 10 Hz
7236.910	47.9	H	74.0	-26.1	PK	231	1.0	RB 1 MHz; VB: 1 MHz
9648.000	39.0	H	74.0	-35.0	AVG	197	1.0	RB 1 MHz; VB: 10 Hz
9648.850	50.9	H	74.0	-23.1	PK	197	1.0	RB 1 MHz; VB: 1 MHz

Note 1: For emissions in restricted bands, the limit of 15.209 was used. For all other emissions, the limit was set 30dB below the level of the fundamental and measured in 100kHz.

Client:	Summit Data Communications	Job Number:	J74548
Model:	802.11abg Compact Flash Card	T-Log Number:	T74640
Contact:	Jerry Pohmurski	Account Manager:	Christine Krebill
Standard:	FCC 15.247/RSS 210	Class:	N/A

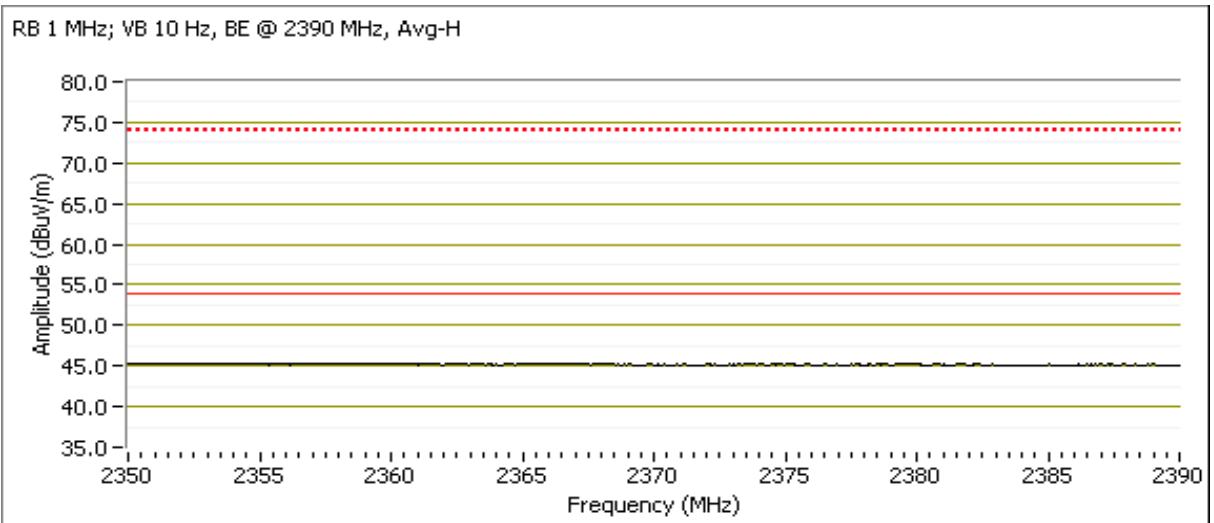
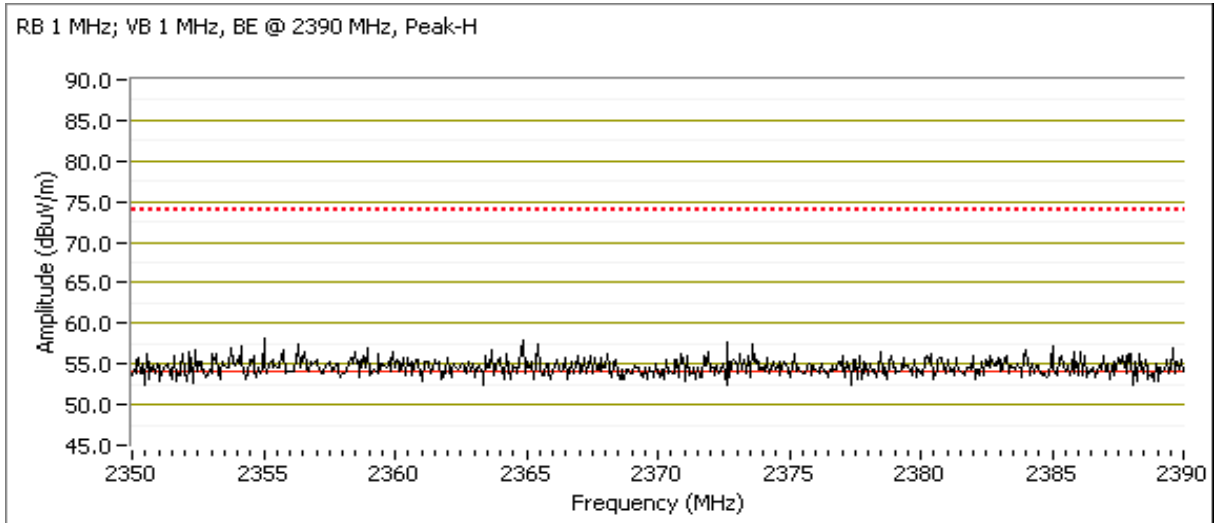

Client:	Summit Data Communications	Job Number:	J74548
Model:	802.11abg Compact Flash Card	T-Log Number:	T74640
Contact:	Jerry Pohmurski	Account Manager:	Christine Krebill
Standard:	FCC 15.247/RSS 210	Class:	N/A

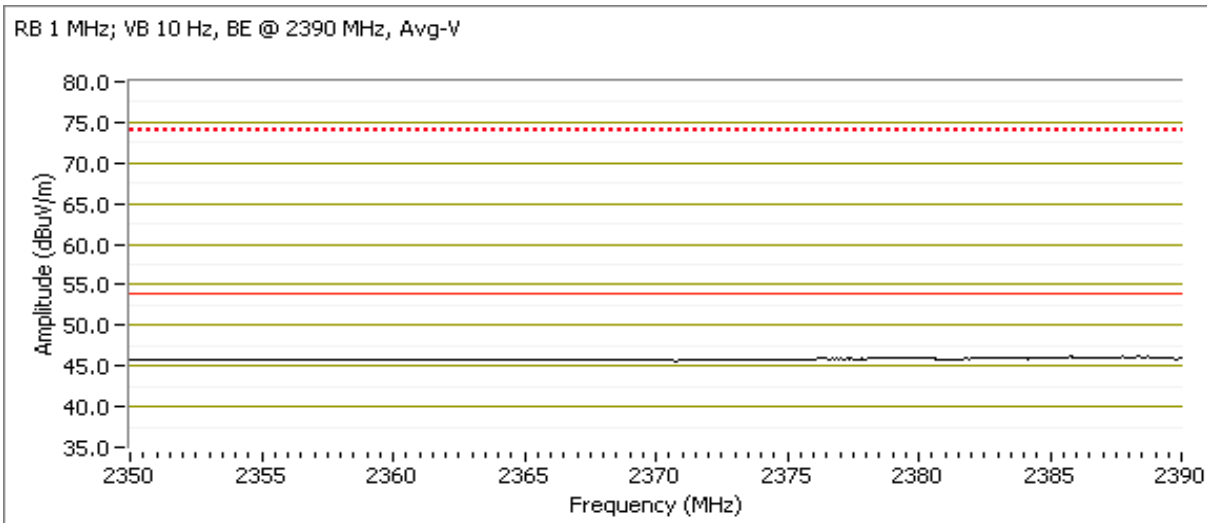
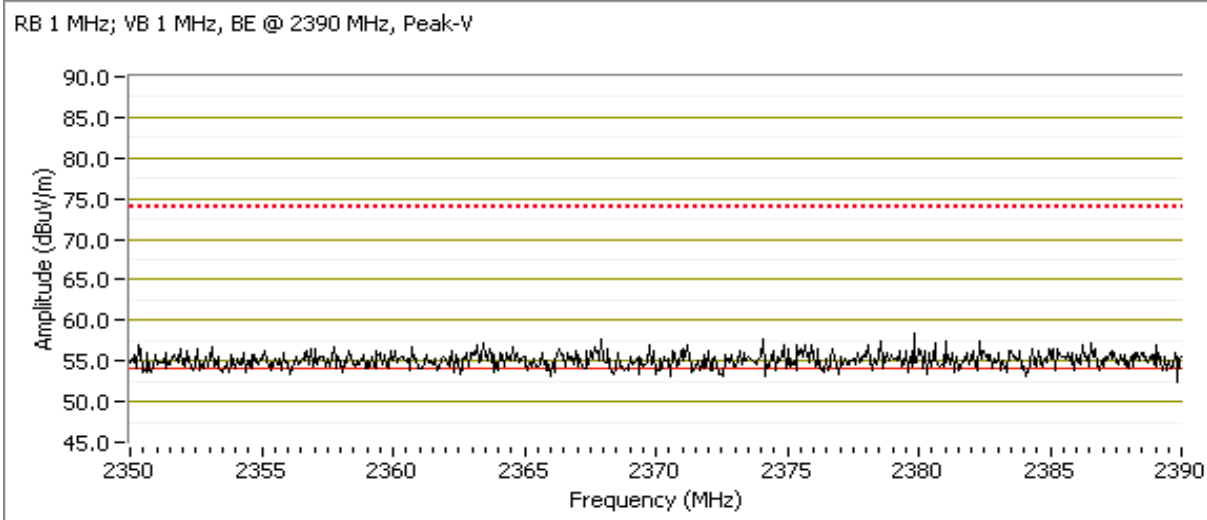

Client:	Summit Data Communications	Job Number:	J74548
Model:	802.11abg Compact Flash Card	T-Log Number:	T74640
		Account Manager:	Christine Krebill
Contact:	Jerry Pohmurski		
Standard:	FCC 15.247/RSS 210	Class:	N/A

Run #1b: Center Channel @ 2437 MHz

Frequency MHz	Level dB μ V/m	Pol v/h	15.209 / 15.247		Detector Pk/QP/Avg	Azimuth degrees	Height meters	Comments
			Limit	Margin				
4874.100	47.6	V	54.0	-6.4	AVG	64	1.0	RB 1 MHz; VB: 10 Hz
4874.100	50.8	V	74.0	-23.2	PK	64	1.0	RB 1 MHz; VB: 1 MHz
7311.870	36.2	V	54.0	-17.8	AVG	248	1.0	RB 1 MHz; VB: 10 Hz
7310.100	47.5	V	74.0	-26.5	PK	248	1.0	RB 1 MHz; VB: 1 MHz
9747.990	39.9	V	74.0	-34.1	AVG	0	1.0	RB 1 MHz; VB: 10 Hz
9747.830	50.9	V	74.0	-23.1	PK	0	1.0	RB 1 MHz; VB: 1 MHz
12184.540	41.0	V	54.0	-13.0	AVG	246	1.0	RB 1 MHz; VB: 10 Hz
12185.600	53.0	V	74.0	-21.0	PK	246	1.0	RB 1 MHz; VB: 1 MHz
4874.120	44.7	H	54.0	-9.3	AVG	175	1.7	RB 1 MHz; VB: 10 Hz
4874.020	48.9	H	74.0	-25.1	PK	175	1.7	RB 1 MHz; VB: 1 MHz
7311.480	35.9	H	54.0	-18.1	AVG	37	1.0	RB 1 MHz; VB: 10 Hz
7310.580	47.2	H	74.0	-26.8	PK	37	1.0	RB 1 MHz; VB: 1 MHz
9747.640	38.7	H	74.0	-35.3	AVG	0	1.0	RB 1 MHz; VB: 10 Hz
9748.870	49.9	H	74.0	-24.1	PK	0	1.0	RB 1 MHz; VB: 1 MHz
12184.470	40.9	H	54.0	-13.1	AVG	201	1.0	RB 1 MHz; VB: 10 Hz
12184.220	51.7	H	74.0	-22.3	PK	201	1.0	RB 1 MHz; VB: 1 MHz

Note 1: For emissions in restricted bands, the limit of 15.209 was used. For all other emissions, the limit was set 30dB below the level of the fundamental and measured in 100kHz.

Client:	Summit Data Communications	Job Number:	J74548
Model:	802.11abg Compact Flash Card	T-Log Number:	T74640
Contact:	Jerry Pohmurski	Account Manager:	Christine Krebill
Standard:	FCC 15.247/RSS 210	Class:	N/A

Run #1c: High Channel @ 2462 MHz

Fundamental Signal Field Strength: Peak and average values measured in 1 MHz, and peak value measured in 100kHz

Frequency MHz	Level dB μ V/m	Pol v/h	15.209 / 15.247		Detector Pk/QP/Avg	Azimuth degrees	Height meters	Comments
			Limit	Margin				
2465.010	101.4	V	-	-	AVG	337	1.0	RB 1 MHz; VB: 10 Hz
2464.940	103.9	V	-	-	PK	337	1.0	RB 1 MHz; VB: 1 MHz
2465.370	98.5	V	-	-	PK	337	1.0	RB 100 kHz; VB: 100 kHz
2459.640	94.4	H	-	-	AVG	200	1.0	RB 1 MHz; VB: 10 Hz
2459.850	97.0	H	-	-	PK	200	1.0	RB 1 MHz; VB: 1 MHz
2459.280	92.1	H	-	-	PK	200	1.0	RB 100 kHz; VB: 100 kHz

Fundamental emission level @ 3m in 100kHz RBW:	97	
Limit for emissions outside of restricted bands:	77 dB μ V/m	Limit is -20dBc (Peak power measurement)
Limit for emissions outside of restricted bands:	67 dB μ V/m	Limit is -30dBc (UNII power measurement)

Band Edge Signal Field Strength

Frequency MHz	Level dB μ V/m	Pol v/h	15.209 / 15.247		Detector Pk/QP/Avg	Azimuth degrees	Height meters	Comments
			Limit	Margin				
2483.530	48.7	V	54.0	-5.3	AVG	337	1.0	MHz; VB: 10 Hz
2484.270	59.0	V	74.0	-15.0	PK	337	1.0	MHz; VB: 1 MHz
2483.500	47.5	H	54.0	-6.5	AVG	200	1.0	MHz; VB: 10 Hz
2483.940	58.5	H	74.0	-15.5	PK	200	1.0	MHz; VB: 1 MHz

Other Spurious Emissions

Frequency MHz	Level dB μ V/m	Pol v/h	15.209 / 15.247		Detector Pk/QP/Avg	Azimuth degrees	Height meters	Comments
			Limit	Margin				
4924.100	49.3	V	54.0	-4.7	AVG	28	1.1	MHz; VB: 10 Hz
4924.100	47.1	H	54.0	-6.9	AVG	216	1.0	MHz; VB: 10 Hz
12311.180	40.7	H	54.0	-13.3	AVG	0	1.0	MHz; VB: 10 Hz
12311.150	40.6	V	54.0	-13.4	AVG	360	1.0	MHz; VB: 10 Hz
7384.880	38.1	V	54.0	-15.9	AVG	292	1.7	MHz; VB: 10 Hz
7384.500	36.0	H	54.0	-18.0	AVG	0	1.0	MHz; VB: 10 Hz
4923.940	52.1	V	74.0	-21.9	PK	28	1.1	MHz; VB: 1 MHz
12310.800	51.8	V	74.0	-22.2	PK	360	1.0	MHz; VB: 1 MHz
12310.630	51.7	H	74.0	-22.3	PK	0	1.0	MHz; VB: 1 MHz
9847.180	51.2	V	74.0	-22.8	PK	0	1.0	MHz; VB: 1 MHz
4924.000	50.9	H	74.0	-23.1	PK	216	1.0	MHz; VB: 1 MHz
9848.320	49.8	H	74.0	-24.2	PK	360	1.0	MHz; VB: 1 MHz
7386.580	48.8	V	74.0	-25.2	PK	292	1.7	MHz; VB: 1 MHz
7385.540	47.5	H	74.0	-26.5	PK	0	1.0	MHz; VB: 1 MHz
9848.040	39.2	V	74.0	-34.8	AVG	0	1.0	MHz; VB: 10 Hz
9847.870	38.7	H	74.0	-35.3	AVG	360	1.0	MHz; VB: 10 Hz

Note 1: For emissions in restricted bands, the limit of 15.209 was used. For all other emissions, the limit was set 30dB below the level of the fundamental and measured in 100kHz.

Client:	Summit Data Communications	Job Number:	J74548
Model:	802.11abg Compact Flash Card	T-Log Number:	T74640
Contact:	Jerry Pohmurski	Account Manager:	Christine Krebill
Standard:	FCC 15.247/RSS 210	Class:	N/A

RB 1 MHz; VB 1 MHz, BE @ 2483.5 MHz, Peak-V

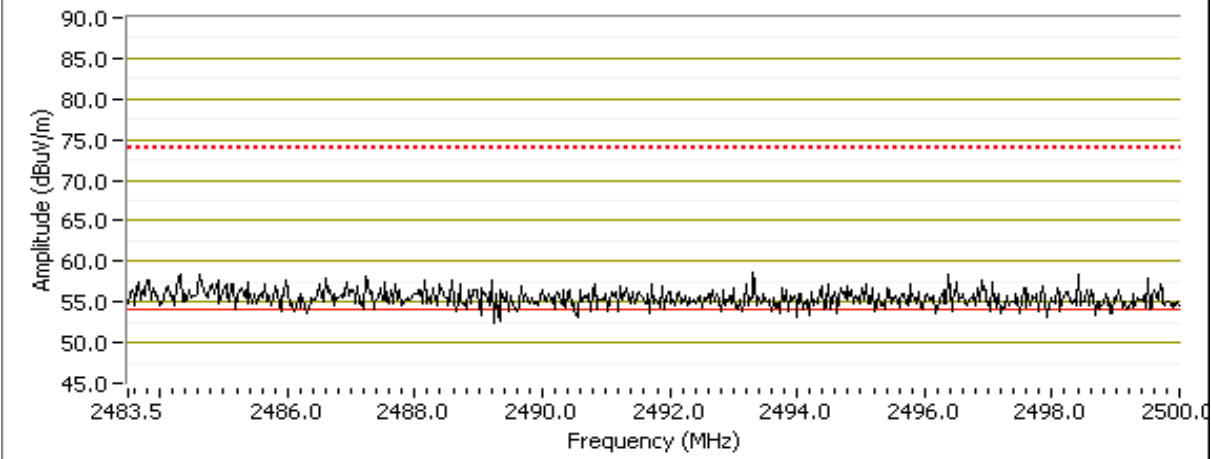

RB 1 MHz; VB 10 Hz, BE @ 2483.5 MHz, Avg-V

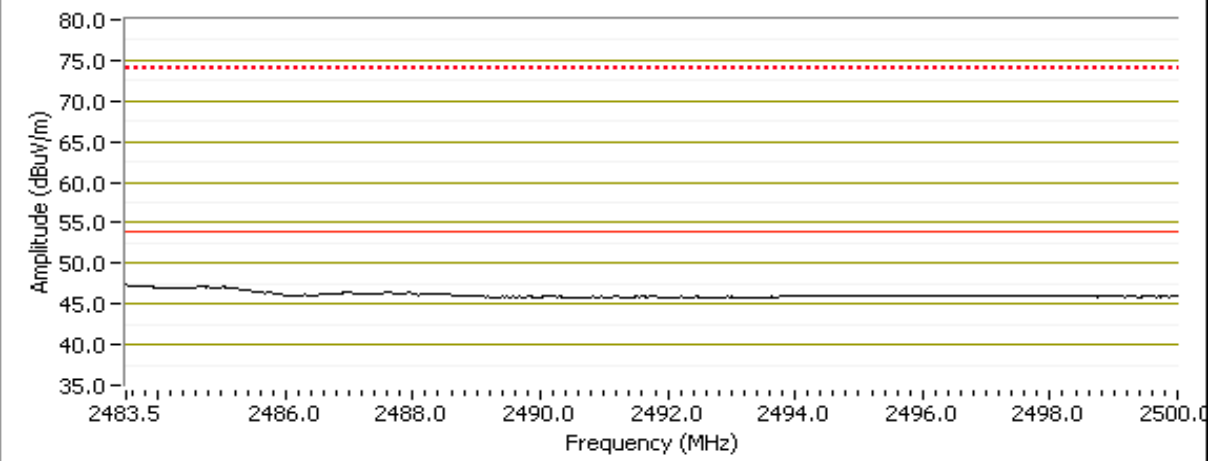

Client:	Summit Data Communications	Job Number:	J74548
Model:	802.11abg Compact Flash Card	T-Log Number:	T74640
Contact:	Jerry Pohmurski	Account Manager:	Christine Krebill
Standard:	FCC 15.247/RSS 210	Class:	N/A

RB 1 MHz; VB 1 MHz, BE @ 2483.5 MHz, Peak-H

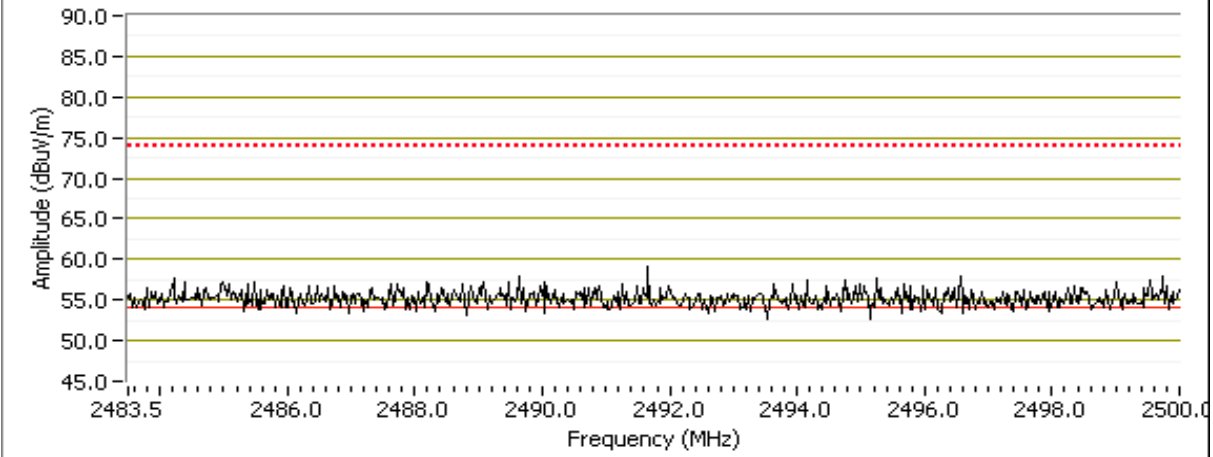

RB 1 MHz; VB 10 Hz, BE @ 2483.5 MHz, Avg-H

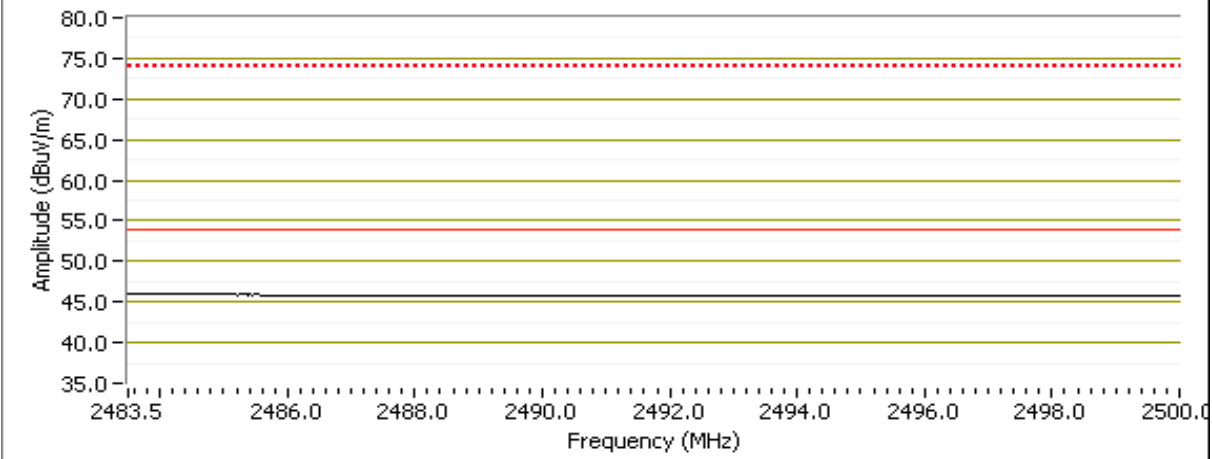

Client:	Summit Data Communications	Job Number:	J74548
Model:	802.11abg Compact Flash Card	T-Log Number:	T74640
		Account Manager:	Christine Krebill
Contact:	Jerry Pohmurski		
Standard:	FCC 15.247/RSS 210	Class:	N/A

Run #2: Radiated Spurious Emissions, 30 - 26000 MHz. Operating Mode: 802.11g

Date of Test: 2/23/2009	Config. Used: 1
Test Engineer: Suhaila Khushzad	Config Change: None
Test Location: OATS #1	Host Unit Voltage 120V/60Hz

Ambient Conditions:

Temperature:	16.1 °C
Rel. Humidity:	72 %

Run #2a: Low Channel @ 2412 MHz

Fundamental Signal Field Strength: Peak and average values measured in 1 MHz, and peak value measured in 100kHz

Frequency	Level	Pol	15.209 / 15.247		Detector	Azimuth	Height	Comments
MHz	dB μ V/m	v/h	Limit	Margin	Pk/QP/Avg	degrees	meters	
2407.770	85.4	H	-	-	AVG	32	1.0	RB 1 MHz; VB: 10 Hz
2408.420	93.9	H	-	-	PK	32	1.0	RB 1 MHz; VB: 1 MHz
2407.630	97.2	V	-	-	AVG	340	1.1	RB 1 MHz; VB: 10 Hz
2414.150	105.4	V	-	-	PK	340	1.1	RB 1 MHz; VB: 1 MHz
2416.590	95.3	V	-	-	PK	340	1.1	RB 100 kHz; VB: 100 kHz
2413.790	85.2	H	-	-	PK	32	1.0	RB 100 kHz; VB: 100 kHz

Fundamental emission level @ 3m in 100kHz RBW:	95.3	dB μ V/m	
Limit for emissions outside of restricted bands:	75.3	dB μ V/m	Limit is -20dBc (Peak power measurement)
Limit for emissions outside of restricted bands:	65.3	dB μ V/m	Limit is -30dBc (UNII power measurement)

Band Edge Signal Field Strength

Frequency	Level	Pol	15.209 / 15.247		Detector	Azimuth	Height	Comments
MHz	dB μ V/m	v/h	Limit	Margin	Pk/QP/Avg	degrees	meters	
2390.000	48.6	V	54.0	-5.4	AVG	340	1.1	MHz; VB: 10 Hz
2389.470	61.3	V	74.0	-12.7	PK	340	1.1	MHz; VB: 1 MHz
2389.330	46.6	H	54.0	-7.4	AVG	32	1.0	MHz; VB: 10 Hz
2351.600	57.9	H	74.0	-16.1	PK	32	1.0	MHz; VB: 1 MHz

Client:	Summit Data Communications	Job Number:	J74548
Model:	802.11abg Compact Flash Card	T-Log Number:	T74640
Contact:	Jerry Pohmurski	Account Manager:	Christine Krebill
Standard:	FCC 15.247/RSS 210	Class:	N/A

Other Spurious Emissions

Frequency MHz	Level dB μ V/m	Pol v/h	15.209 / 15.247		Detector Pk/QP/Avg	Azimuth degrees	Height meters	Comments
			Limit	Margin				
7250.480	35.4	H	54.0	-18.6	AVG	112	1.0	MHz; VB: 10 Hz
4802.710	32.9	H	54.0	-21.1	AVG	8	1.0	MHz; VB: 10 Hz
4821.630	31.7	V	54.0	-22.3	AVG	141	2.1	MHz; VB: 10 Hz
9642.910	48.6	V	74.0	-25.4	PK	93	1.0	MHz; VB: 1 MHz
7247.820	47.5	V	74.0	-26.5	PK	61	1.0	MHz; VB: 1 MHz
7251.120	46.3	H	74.0	-27.7	PK	112	1.0	MHz; VB: 1 MHz
4840.980	44.3	H	74.0	-29.7	PK	8	1.0	MHz; VB: 1 MHz
4822.500	43.0	V	74.0	-31.0	PK	141	2.1	MHz; VB: 1 MHz
9649.650	37.6	V	74.0	-36.4	AVG	93	1.0	MHz; VB: 10 Hz
7247.470	35.6	V	74.0	-38.4	AVG	61	1.0	MHz; VB: 10 Hz

Note 1: For emissions in restricted bands, the limit of 15.209 was used. For all other emissions, the limit was set 30dB below the level of the fundamental and measured in 100kHz.

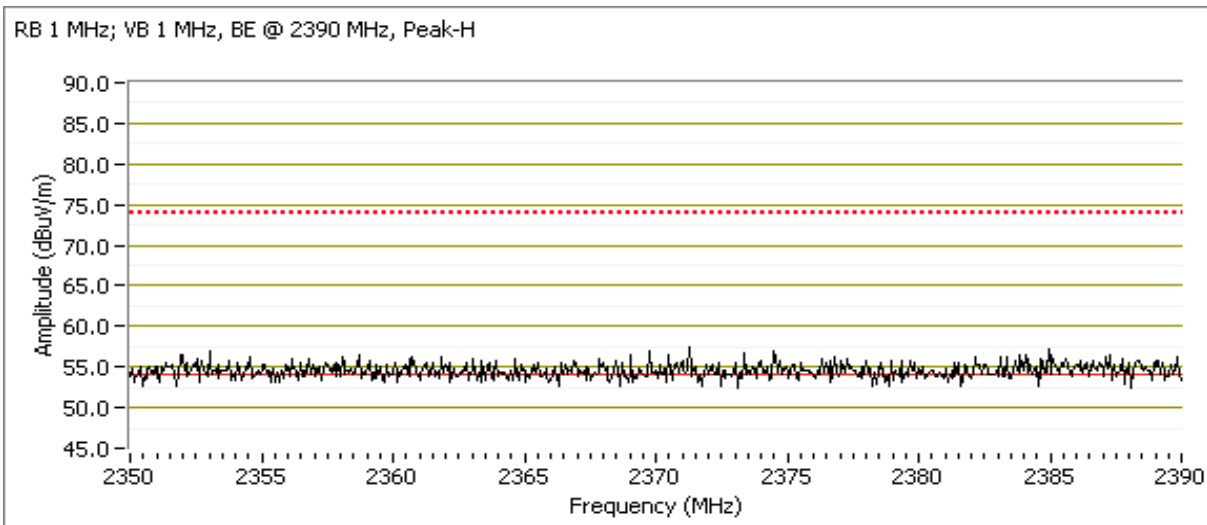

Client:	Summit Data Communications	Job Number:	J74548
Model:	802.11abg Compact Flash Card	T-Log Number:	T74640
Contact:	Jerry Pohmurski	Account Manager:	Christine Krebill
Standard:	FCC 15.247/RSS 210	Class:	N/A

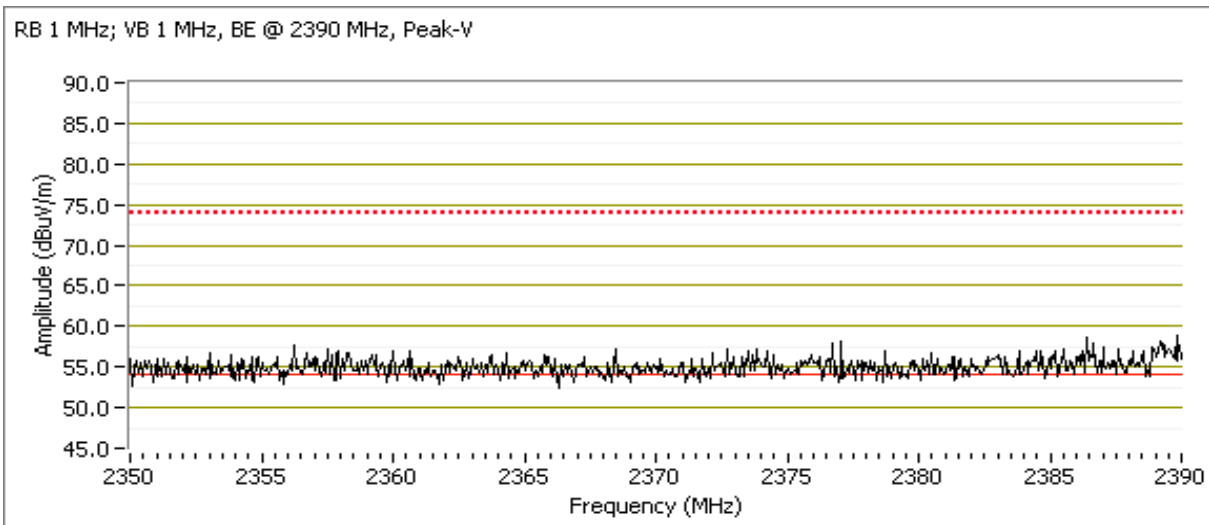
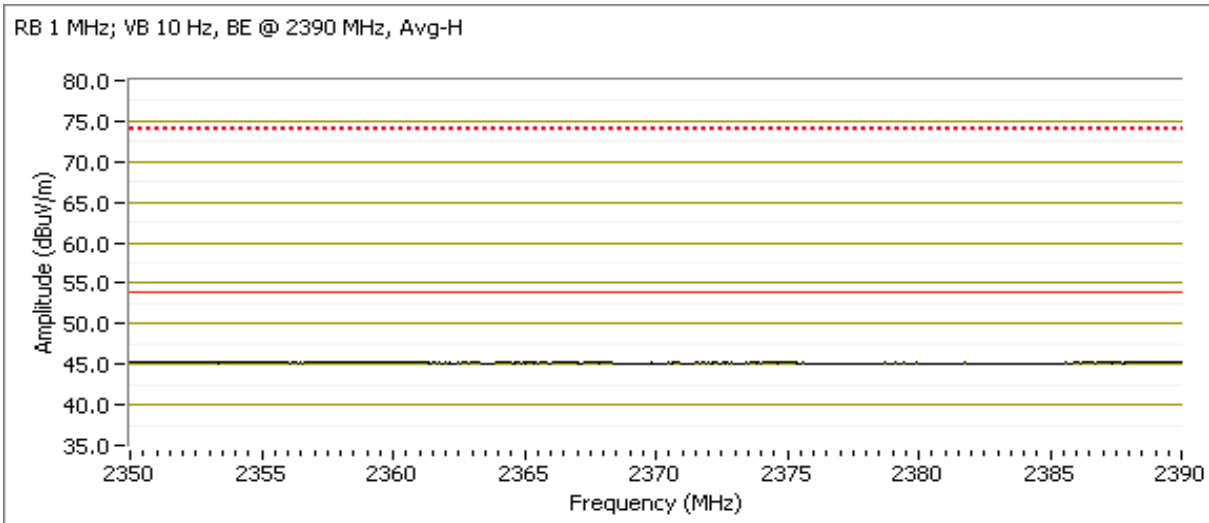

Client:	Summit Data Communications	Job Number:	J74548
Model:	802.11abg Compact Flash Card	T-Log Number:	T74640
Contact:	Jerry Pohmurski	Account Manager:	Christine Krebill
Standard:	FCC 15.247/RSS 210	Class:	N/A

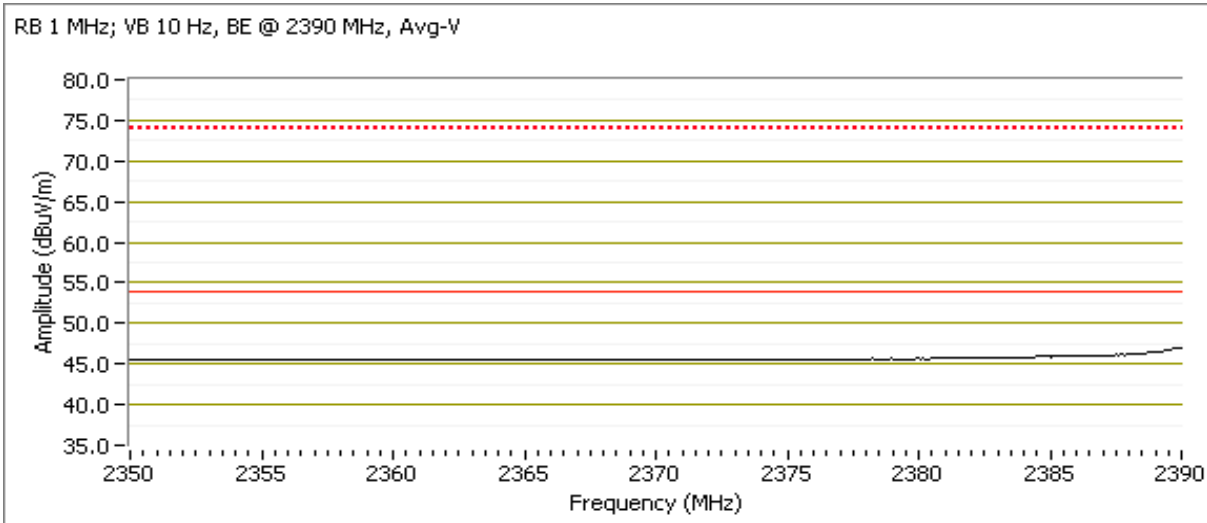

Run #2b: Center Channel @ 2437 MHz

Fundamental Signal Field Strength: Peak and average values measured in 1 MHz, and peak value measured in 100kHz

Frequency	Level	Pol	15.209 / 15.247		Detector	Azimuth	Height	Comments	
MHz	dB μ V/m	v/h	Limit	Margin	Pk/QP/Avg	degrees	meters		
2440.420	96.0	V	120.0	-	-	347	1.0	RB 1 MHz; VB: 10 Hz	
2441.900	104.4	V	120.0	-	-	347	1.0	RB 1 MHz; VB: 1 MHz	
2434.850	83.8	H	120.0	-	-	353	1.0	RB 1 MHz; VB: 10 Hz	
2434.130	92.0	H	120.0	-	-	353	1.0	RB 1 MHz; VB: 1 MHz	
2439.940	84.1	H	120.0	-	-	353	1.0	RB 100 kHz; VB: 100 kHz	
2433.560	95.5	V	120.0	-	-	347	1.0	RB 100 kHz; VB: 100 kHz	
Fundamental emission level @ 3m in 100kHz RBW:					95.5	dB μ V/m			
Limit for emissions outside of restricted bands:					75.5	dB μ V/m	Limit is -20dBc (Peak power measurement)		
Limit for emissions outside of restricted bands:					65.5	dB μ V/m	Limit is -30dBc (UNII power measurement)		
Frequency	Level	Pol	15.209 / 15.247		Detector	Azimuth	Height	Comments	
MHz	dB μ V/m	v/h	Limit	Margin	Pk/QP/Avg	degrees	meters		
7332.070	35.7	H	54.0	-18.3	AVG	149	1.0	RB 1 MHz; VB: 10 Hz	
7330.420	35.6	V	54.0	-18.4	AVG	324	1.7	RB 1 MHz; VB: 10 Hz	
4858.810	33.3	V	54.0	-20.7	AVG	287	1.0	RB 1 MHz; VB: 10 Hz	
4860.100	33.2	H	54.0	-20.8	AVG	34	1.0	RB 1 MHz; VB: 10 Hz	
9739.970	49.4	V	74.0	-24.6	PK	0	1.8	RB 1 MHz; VB: 1 MHz	
9741.980	49.3	H	74.0	-24.7	PK	218	1.0	RB 1 MHz; VB: 1 MHz	
7323.650	46.6	H	74.0	-27.4	PK	149	1.0	RB 1 MHz; VB: 1 MHz	
7312.340	46.5	V	74.0	-27.5	PK	324	1.7	RB 1 MHz; VB: 1 MHz	

Client:	Summit Data Communications	Job Number:	J74548
Model:	802.11abg Compact Flash Card	T-Log Number:	T74640
		Account Manager:	Christine Krebill
Contact:	Jerry Pohmurski		
Standard:	FCC 15.247/RSS 210	Class:	N/A

Run #2b: Center Channel @ 2437 MHz

4872.780	44.9	H	74.0	-29.1	PK	34	1.0	RB 1 MHz; VB: 1 MHz
4881.450	44.7	V	74.0	-29.3	PK	287	1.0	RB 1 MHz; VB: 1 MHz
9747.930	37.7	V	74.0	-36.3	AVG	0	1.8	RB 1 MHz; VB: 10 Hz
9728.510	37.7	H	74.0	-36.3	AVG	218	1.0	RB 1 MHz; VB: 10 Hz

Note 1: For emissions in restricted bands, the limit of 15.209 was used. For all other emissions, the limit was set 30dB below the level of the fundamental and measured in 100kHz.

Client:	Summit Data Communications	Job Number:	J74548
Model:	802.11abg Compact Flash Card	T-Log Number:	T74640
Contact:	Jerry Pohmurski	Account Manager:	Christine Krebill
Standard:	FCC 15.247/RSS 210	Class:	N/A

Run #2c: High Channel @ 2462 MHz

Fundamental Signal Field Strength: Peak and average values measured in 1 MHz, and peak value measured in 100kHz

Frequency MHz	Level dB μ V/m	Pol v/h	15.209 / 15.247		Detector Pk/QP/Avg	Azimuth degrees	Height meters	Comments
			Limit	Margin				
2466.870	95.4	V	-	-	AVG	293	1.0	RB 1 MHz; VB: 10 Hz
2467.020	104.1	V	-	-	PK	293	1.0	RB 1 MHz; VB: 1 MHz
2459.060	87.4	H	-	-	AVG	16	1.0	RB 1 MHz; VB: 10 Hz
2467.230	95.9	H	-	-	PK	16	1.0	RB 1 MHz; VB: 1 MHz
2460.710	85.7	H	-	-	PK	16	1.0	RB 100 kHz; VB: 100 kHz
2457.200	93.8	V	-	-	PK	293	1.0	RB 100 kHz; VB: 100 kHz

Fundamental emission level @ 3m in 100kHz RBW:	93.8	
Limit for emissions outside of restricted bands:	73.8 dB μ V/m	Limit is -20dBc (Peak power measurement)
Limit for emissions outside of restricted bands:	63.8 dB μ V/m	Limit is -30dBc (UNII power measurement)

Band Edge Signal Field Strength

Frequency MHz	Level dB μ V/m	Pol v/h	15.209 / 15.247		Detector Pk/QP/Avg	Azimuth degrees	Height meters	Comments
			Limit	Margin				
2483.530	52.1	V	54.0	-1.9	AVG	293	1.0	RB 1 MHz; VB: 10 Hz
2483.550	66.4	V	74.0	-7.6	PK	293	1.0	RB 1 MHz; VB: 1 MHz
2483.580	47.9	H	54.0	-6.1	AVG	16	1.0	RB 1 MHz; VB: 10 Hz
2486.960	58.8	H	74.0	-15.2	PK	16	1.0	RB 1 MHz; VB: 1 MHz

Other Spurious Emissions

Frequency MHz	Level dB μ V/m	Pol v/h	15.209 / 15.247		Detector Pk/QP/Avg	Azimuth degrees	Height meters	Comments
			Limit	Margin				
7333.640	35.1	V	54.0	-18.9	AVG	111	1.0	RB 1 MHz; VB: 10 Hz
7393.490	35.0	H	54.0	-19.0	AVG	167	1.0	RB 1 MHz; VB: 10 Hz
4924.220	34.7	H	54.0	-19.3	AVG	202	1.7	RB 1 MHz; VB: 10 Hz
4924.140	33.8	V	54.0	-20.2	AVG	327	1.4	RB 1 MHz; VB: 10 Hz
9860.400	48.3	V	74.0	-25.7	PK	147	1.0	RB 1 MHz; VB: 1 MHz
9834.890	48.2	H	74.0	-25.8	PK	196	1.0	RB 1 MHz; VB: 1 MHz
7372.640	46.5	H	74.0	-27.5	PK	167	1.0	RB 1 MHz; VB: 1 MHz
7356.420	46.1	V	74.0	-27.9	PK	111	1.0	RB 1 MHz; VB: 1 MHz
4922.850	45.5	V	74.0	-28.5	PK	327	1.4	RB 1 MHz; VB: 1 MHz
4921.560	45.3	H	74.0	-28.7	PK	202	1.7	RB 1 MHz; VB: 1 MHz
9848.290	37.4	H	74.0	-36.6	AVG	196	1.0	RB 1 MHz; VB: 10 Hz
9827.070	37.3	V	74.0	-36.7	AVG	147	1.0	RB 1 MHz; VB: 10 Hz

Note 1: For emissions in restricted bands, the limit of 15.209 was used. For all other emissions, the limit was set 30dB below the level of the fundamental and measured in 100kHz.

Client:	Summit Data Communications	Job Number:	J74548
Model:	802.11abg Compact Flash Card	T-Log Number:	T74640
Contact:	Jerry Pohmurski	Account Manager:	Christine Krebill
Standard:	FCC 15.247/RSS 210	Class:	N/A

RB 1 MHz; VB 1 MHz, BE @ 2483.5 MHz, Peak-V

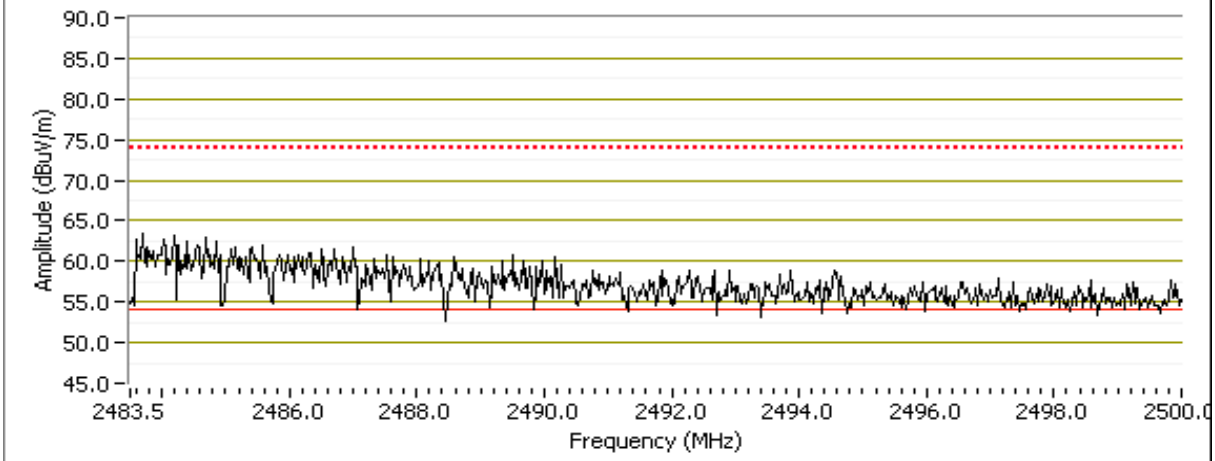

RB 1 MHz; VB 10 Hz, BE @ 2483.5 MHz, Avg-V

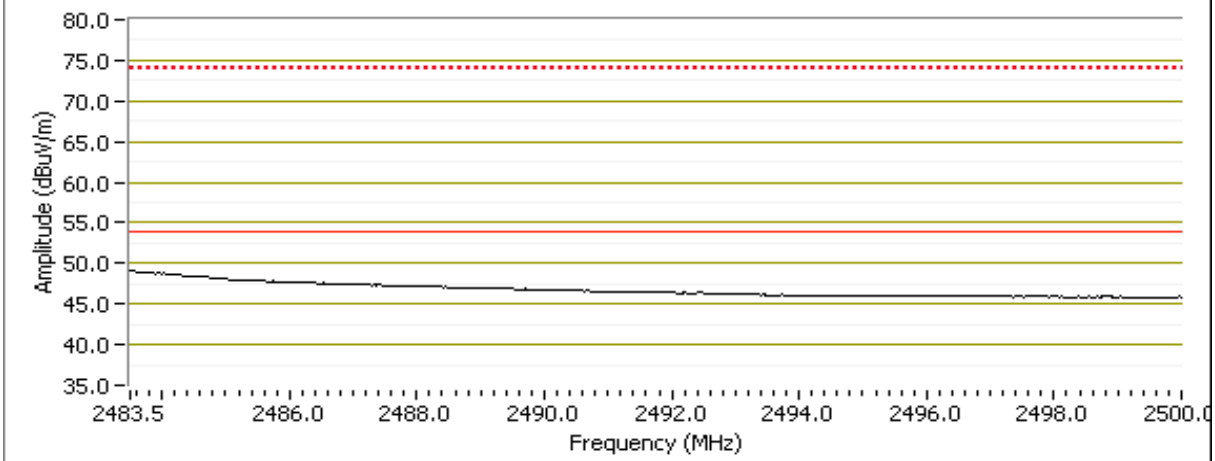

Client:	Summit Data Communications	Job Number:	J74548
Model:	802.11abg Compact Flash Card	T-Log Number:	T74640
Contact:	Jerry Pohmurski	Account Manager:	Christine Krebill
Standard:	FCC 15.247/RSS 210	Class:	N/A

RB 1 MHz; VB 1 MHz, BE @ 2483.5 MHz, Peak-H

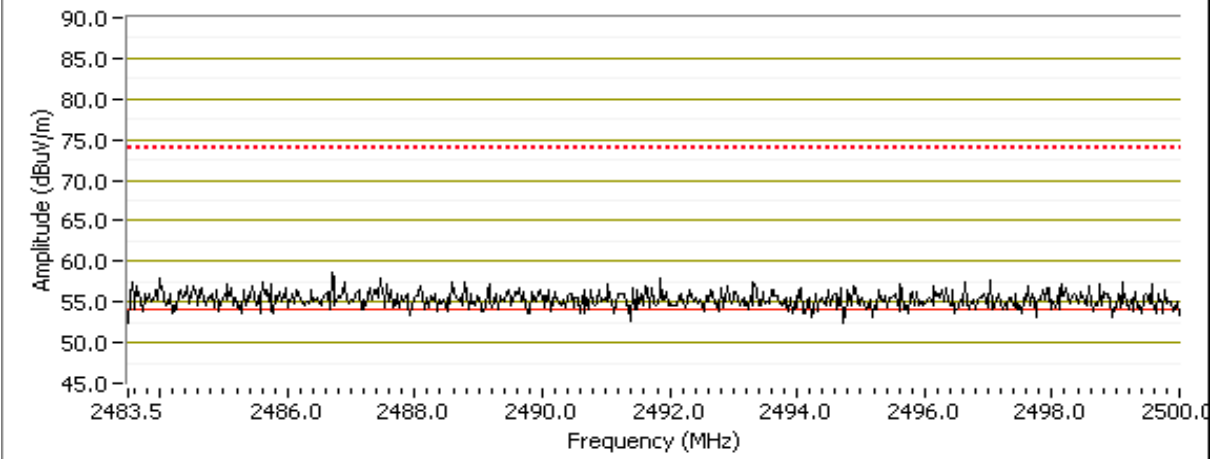

RB 1 MHz; VB 10 Hz, BE @ 2483.5 MHz, Avg-H

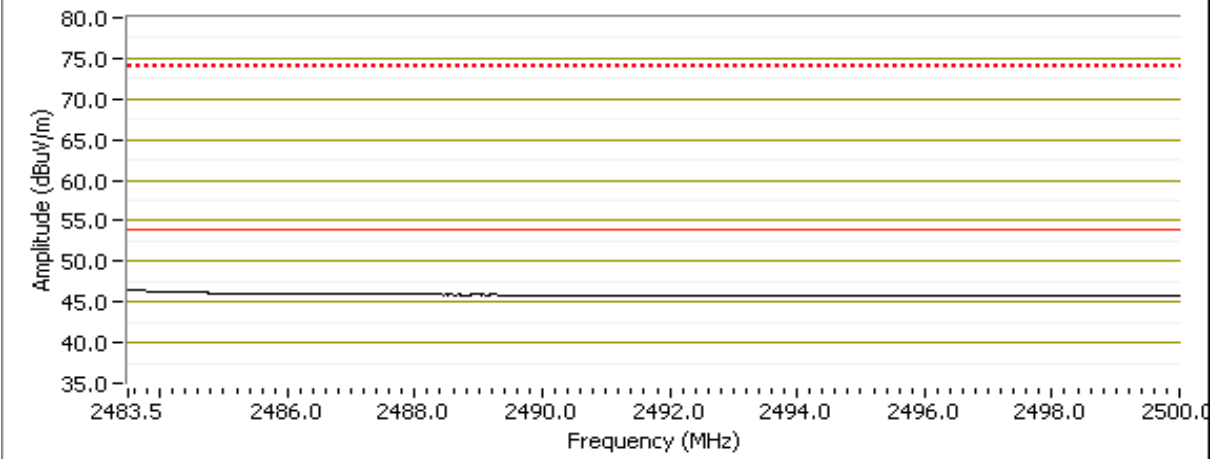

Client:	Summit Data Communications	Job Number:	J74548
Model:	802.11abg Compact Flash Card	T-Log Number:	T74640
		Account Manager:	Christine Krebill
Contact:	Jerry Pohmurski		
Standard:	FCC 15.247/RSS 210	Class:	N/A

Run #3: Radiated Spurious Emissions, 30 - 40000 MHz. Operating Mode: 802.11a

Date of Test: 3/3/2009
 Test Engineer: Mehran Birgani
 Test Location: SVOATS #1

Config. Used: 1
 Config Change: None
 Host Unit Voltage 120V/60Hz

Ambient Conditions: Temperature: 10 °C
 Rel. Humidity: 100 %

Run #3a: Low Channel @ 5745 MHz

Frequency MHz	Level dBµV/m	Pol V/H	15.209 / 15.247		Detector Pk/QP/Avg	Azimuth degrees	Height meters	Comments
			Limit	Margin				
11490.270	50.4	H	54.0	-3.6	AVG	111	1.4	
11492.280	52.2	V	54.0	-1.8	AVG	34	1.5	
17233.220	44.6	V	54.0	-9.4	AVG	360	1.9	Note 1, Noise Floor
11492.520	67.4	V	74.0	-6.6	PK	34	1.5	
11492.630	65.7	H	74.0	-8.3	PK	111	1.4	
17240.680	55.8	V	74.0	-18.2	PK	360	1.9	Note 1, Noise Floor

Note 1: Signal is not in a restricted band but the more stringent restricted band limit was used.

Run #3b: Center Channel @ 5485 MHz

Frequency MHz	Level dBµV/m	Pol V/H	15.209 / 15.247		Detector Pk/QP/Avg	Azimuth degrees	Height meters	Comments
			Limit	Margin				
11570.300	48.7	H	54.0	-5.3	AVG	51	1.6	
11572.050	47.5	V	54.0	-6.5	AVG	51	1.1	
17353.540	45.5	V	54.0	-8.5	AVG	0	1.0	Note 1, Noise Floor
11572.650	62.2	V	74.0	-11.8	PK	51	1.1	
11572.720	63.9	H	74.0	-10.1	PK	51	1.6	
17354.400	57.2	V	74.0	-16.8	PK	0	1.0	Note 1, Noise Floor

Note 1: Signal is not in a restricted band but the more stringent restricted band limit was used.

Client:	Summit Data Communications	Job Number:	J74548
Model:	802.11abg Compact Flash Card	T-Log Number:	T74640
		Account Manager:	Christine Krebill
Contact:	Jerry Pohmurski		
Standard:	FCC 15.247/RSS 210	Class:	N/A

Run #3c: High Channel @ 5805 MHz (Channel 161)
Other Spurious Emissions

Frequency MHz	Level dB μ V/m	Pol v/h	15.209 / 15.247		Detector Pk/QP/Avg	Azimuth degrees	Height meters	Comments
			Limit	Margin				
17414.290	45.7	H	54.0	-8.3	AVG	316	1.0	MHz; VB: 10 Hz
17413.640	44.8	V	54.0	-9.2	AVG	360	1.0	MHz; VB: 10 Hz
11609.870	38.1	H	54.0	-15.9	AVG	141	1.0	MHz; VB: 10 Hz
17413.660	57.9	H	74.0	-16.1	PK	316	1.0	MHz; VB: 1 MHz
11608.710	37.8	V	54.0	-16.2	AVG	360	1.0	MHz; VB: 10 Hz
17415.070	57.2	V	74.0	-16.8	PK	360	1.0	MHz; VB: 1 MHz
11609.130	50.9	V	74.0	-23.1	PK	360	1.0	MHz; VB: 1 MHz
11609.260	50.5	H	74.0	-23.5	PK	141	1.0	MHz; VB: 1 MHz

Note 1: Signal is not in a restricted band but the more stringent restricted band limit was used.

Client:	Summit Data Communications	Job Number:	J74548
Model:	802.11abg Compact Flash Card	T-Log Number:	T74640
		Account Manager:	Christine Krebill
Contact:	Jerry Pohmurski		
Standard:	FCC 15.247/RSS 210	Class:	-

Radiated Spurious Emissions

Test Specific Details

Objective: The objective of this test session is to perform final qualification testing of the EUT with respect to the specification listed above.

General Test Configuration

The EUT and all local support equipment were located on the turntable for radiated emissions testing.

The test distance and extrapolation factor (if applicable) are detailed under each run description.

Note, **preliminary** testing indicates that the emissions were maximized by orientation of the EUT and elevation of the measurement antenna. **Maximized** testing indicated that the emissions were maximized by orientation of the EUT, elevation of the measurement antenna, and manipulation of the EUT's interface cables.

Ambient Conditions:

Temperature:	10-15 °C
Rel. Humidity:	39-50 %

Summary of Results

Run #	Test Performed	Limit	Result	Margin
1 (802.11b), 2437MHz Larson Antenna, AUX	RE, 1000 - 18000 MHz, Maximized Emissions	RSS-GEN	Pass	34.7dBµV/m (54.3µV/m) @ 7309.5MHz (-19.3dB)
2 (802.11b), 2437MHz PCB Antenna, AUX	RE, 1000 - 18000 MHz, Maximized Emissions	RSS-GEN	Pass	34.8dBµV/m (55.0µV/m) @ 7310.4MHz (-19.2dB)
3 (802.11b), 2437MHz Larson Antenna, MAIN	RE, 1000 - 18000 MHz, Maximized Emissions	RSS-GEN	Pass	34.7dBµV/m (54.3µV/m) @ 7309.6MHz (-19.3dB)
4 (802.11b), 2437MHz PCB Antenna, MAIN	RE, 1000 - 18000 MHz, Maximized Emissions	RSS-GEN	Pass	34.8dBµV/m (55.0µV/m) @ 7310.6MHz (-19.2dB)
5 (802.11a), 5200MHz Larson Antenna, MAIN	RE, 1000 - 18000 MHz, Maximized Emissions	RSS-GEN	Pass	40.1dBµV/m (101.2µV/m) @ 15598.5MHz (-13.9dB)
6 (802.11a), 5200MHz PCB Antenna, MAIN	RE, 1000 - 18000 MHz, Maximized Emissions	RSS-GEN	Pass	39.6dBµV/m (95.5µV/m) @ 15598.5MHz (-14.4dB)
7 (802.11a), 5785MHz Larson Antenna, MAIN	RE, 1000 - 18000 MHz, Maximized Emissions	RSS-GEN	Pass	45.0dBµV/m (177.8µV/m) @ 17353.5MHz (-9.0dB)
8 (802.11a), 5785MHz PCB Antenna, MAIN	RE, 1000 - 18000 MHz, Maximized Emissions	RSS-GEN	Pass	45.0dBµV/m (177.8µV/m) @ 17353.5MHz (-9.0dB)

Modifications Made During Testing

No modifications were made to the EUT during testing

Deviations From The Standard

No deviations were made from the requirements of the standard.

Client:	Summit Data Communications	Job Number:	J74548
Model:	802.11abg Compact Flash Card	T-Log Number:	T74640
		Account Manager:	Christine Krebill
Contact:	Jerry Pohmurski		
Standard:	FCC 15.247/RSS 210	Class:	-

Run #1: Maximized readings, 1000 - 18000 MHz (802.11b with 1.6dBi Antenna (Larson), AUX)

Date of Test: 2/23/2009	Config. Used: 1
Test Engineer:	Config Change: none
Test Location: SVOATS #1	Host Unit Voltage 120V/60Hz

Frequency MHz	Level dB μ V/m	Pol V/H	FCC Class B		Detector Pk/QP/Avg	Azimuth degrees	Height meters	Comments
			Limit	Margin				
1624.610	25.6	H	54.0	-28.4	AVG	360	1.0	RB 1 MHz; VB: 10 Hz
1625.920	31.4	V	54.0	-22.6	AVG	356	1.0	RB 1 MHz; VB: 10 Hz
3249.270	29.6	V	54.0	-24.4	AVG	182	1.0	RB 1 MHz; VB: 10 Hz
3249.590	29.6	H	54.0	-24.4	AVG	360	1.0	RB 1 MHz; VB: 10 Hz
4874.870	31.7	H	54.0	-22.3	AVG	136	1.0	RB 1 MHz; VB: 10 Hz
4875.230	31.7	V	54.0	-22.3	AVG	360	1.0	RB 1 MHz; VB: 10 Hz
6497.160	33.0	V	54.0	-21.0	AVG	24	1.0	RB 1 MHz; VB: 10 Hz
6497.160	32.9	H	54.0	-21.1	AVG	267	1.0	RB 1 MHz; VB: 10 Hz
7309.530	34.7	V	54.0	-19.3	AVG	131	1.5	RB 1 MHz; VB: 10 Hz
7309.710	34.7	H	54.0	-19.3	AVG	304	1.0	RB 1 MHz; VB: 10 Hz
1625.030	40.7	V	74.0	-33.3	PK	356	1.0	RB 1 MHz; VB: 1 MHz
1625.050	36.2	H	74.0	-37.8	PK	360	1.0	RB 1 MHz; VB: 1 MHz
3248.030	40.9	V	74.0	-33.1	PK	182	1.0	RB 1 MHz; VB: 1 MHz
3249.180	41.6	H	74.0	-32.4	PK	360	1.0	RB 1 MHz; VB: 1 MHz
4873.730	43.1	V	74.0	-30.9	PK	360	1.0	RB 1 MHz; VB: 1 MHz
4873.730	42.8	H	74.0	-31.2	PK	136	1.0	RB 1 MHz; VB: 1 MHz
6498.870	44.1	V	74.0	-29.9	PK	24	1.0	RB 1 MHz; VB: 1 MHz
6499.370	43.7	H	74.0	-30.3	PK	267	1.0	RB 1 MHz; VB: 1 MHz
7311.920	46.0	H	74.0	-28.0	PK	304	1.0	RB 1 MHz; VB: 1 MHz
7312.400	45.9	V	74.0	-28.1	PK	131	1.5	RB 1 MHz; VB: 1 MHz

Note 1: Above 1 GHz, the FCC specifies the limit as an average measurement. In addition, the FCC states that the peak reading of any emission above 1 GHz, can not exceed the average limit by more than 20 dB.

Client:	Summit Data Communications	Job Number:	J74548
Model:	802.11abg Compact Flash Card	T-Log Number:	T74640
		Account Manager:	Christine Krebill
Contact:	Jerry Pohmurski		
Standard:	FCC 15.247/RSS 210	Class:	-

Run #2: Maximized readings, 1000 - 18000 MHz (802.11b with 3.8dBi Antenna (PCB), AUX)

Date of Test: 2/23/2009
 Test Engineer:
 Test Location: SVOATS #1

Config. Used: 1
 Config Change: none
 Host Unit Voltage 120V/60Hz

Frequency MHz	Level dB μ V/m	Pol V/H	FCC Class B		Detector Pk/QP/Avg	Azimuth degrees	Height meters	Comments
			Limit	Margin				
1625.870	30.9	H	54.0	-23.1	AVG	325	1.0	RB 1 MHz; VB: 10 Hz
1625.870	30.8	V	54.0	-23.2	AVG	277	1.0	RB 1 MHz; VB: 10 Hz
3249.460	29.7	V	54.0	-24.3	AVG	0	1.0	RB 1 MHz; VB: 10 Hz
3249.920	29.6	H	54.0	-24.4	AVG	360	1.0	RB 1 MHz; VB: 10 Hz
4874.080	31.6	H	54.0	-22.4	AVG	279	1.0	RB 1 MHz; VB: 10 Hz
4874.090	31.7	V	54.0	-22.3	AVG	155	1.0	RB 1 MHz; VB: 10 Hz
6497.160	32.9	V	54.0	-21.1	AVG	356	1.0	RB 1 MHz; VB: 10 Hz
6497.220	32.9	H	54.0	-21.1	AVG	113	1.0	RB 1 MHz; VB: 10 Hz
7309.540	34.7	V	54.0	-19.3	AVG	356	1.0	RB 1 MHz; VB: 10 Hz
7310.350	34.8	H	54.0	-19.2	AVG	55	1.0	RB 1 MHz; VB: 10 Hz
1623.630	45.9	H	74.0	-28.1	PK	325	1.0	RB 1 MHz; VB: 1 MHz
1624.500	37.5	V	74.0	-36.5	PK	277	1.0	RB 1 MHz; VB: 1 MHz
3249.340	40.8	H	74.0	-33.2	PK	360	1.0	RB 1 MHz; VB: 1 MHz
3249.460	41.0	V	74.0	-33.0	PK	0	1.0	RB 1 MHz; VB: 1 MHz
4873.120	42.9	H	74.0	-31.1	PK	279	1.0	RB 1 MHz; VB: 1 MHz
4874.150	43.6	V	74.0	-30.4	PK	155	1.0	RB 1 MHz; VB: 1 MHz
6497.540	44.6	V	74.0	-29.4	PK	356	1.0	RB 1 MHz; VB: 1 MHz
6499.790	44.1	H	74.0	-29.9	PK	113	1.0	RB 1 MHz; VB: 1 MHz
7310.750	45.9	H	74.0	-28.1	PK	55	1.0	RB 1 MHz; VB: 1 MHz
7310.870	46.3	V	74.0	-27.7	PK	356	1.0	RB 1 MHz; VB: 1 MHz

Note 1: Above 1 GHz, the FCC specifies the limit as an average measurement. In addition, the FCC states that the peak reading of any emission above 1 GHz, can not exceed the average limit by more than 20 dB.

Client:	Summit Data Communications	Job Number:	J74548
Model:	802.11abg Compact Flash Card	T-Log Number:	T74640
		Account Manager:	Christine Krebill
Contact:	Jerry Pohmurski		
Standard:	FCC 15.247/RSS 210	Class:	-

Run #3: Maximized readings, 1000 - 18000 MHz (802.11b with 1.6dBi Antenna (Larson), MAIN)

Date of Test: 2/23/2009
 Test Engineer:
 Test Location: SVOATS #1

Config. Used: 1
 Config Change: none
 Host Unit Voltage 120V/60Hz

Frequency MHz	Level dB μ V/m	Pol V/H	FCC Class B		Detector Pk/QP/Avg	Azimuth degrees	Height meters	Comments
			Limit	Margin				
1623.680	25.0	V	54.0	-29.0	AVG	83	1.0	RB 1 MHz; VB: 10 Hz
1624.280	28.1	H	54.0	-25.9	AVG	0	1.0	RB 1 MHz; VB: 10 Hz
3250.520	29.7	V	54.0	-24.3	AVG	68	1.0	RB 1 MHz; VB: 10 Hz
3250.680	29.7	H	54.0	-24.3	AVG	0	1.0	RB 1 MHz; VB: 10 Hz
4874.230	31.7	V	54.0	-22.3	AVG	0	1.0	RB 1 MHz; VB: 10 Hz
4874.920	31.7	H	54.0	-22.3	AVG	360	1.0	RB 1 MHz; VB: 10 Hz
6497.160	32.9	H	54.0	-21.1	AVG	360	1.0	RB 1 MHz; VB: 10 Hz
6497.180	32.9	V	54.0	-21.1	AVG	16	1.0	RB 1 MHz; VB: 10 Hz
7309.610	34.7	V	54.0	-19.3	AVG	356	1.0	RB 1 MHz; VB: 10 Hz
7309.710	34.7	H	54.0	-19.3	AVG	360	1.0	RB 1 MHz; VB: 10 Hz
1623.650	35.2	V	74.0	-38.8	PK	83	1.0	RB 1 MHz; VB: 1 MHz
1624.930	35.7	H	74.0	-38.3	PK	0	1.0	RB 1 MHz; VB: 1 MHz
3248.540	41.6	H	74.0	-32.4	PK	0	1.0	RB 1 MHz; VB: 1 MHz
3249.670	40.8	V	74.0	-33.2	PK	68	1.0	RB 1 MHz; VB: 1 MHz
4873.810	43.7	V	74.0	-30.3	PK	0	1.0	RB 1 MHz; VB: 1 MHz
4873.890	42.9	H	74.0	-31.1	PK	360	1.0	RB 1 MHz; VB: 1 MHz
6498.250	43.8	V	74.0	-30.2	PK	16	1.0	RB 1 MHz; VB: 1 MHz
6499.960	43.6	H	74.0	-30.4	PK	360	1.0	RB 1 MHz; VB: 1 MHz
7309.730	46.0	H	74.0	-28.0	PK	360	1.0	RB 1 MHz; VB: 1 MHz
7310.100	46.7	V	74.0	-27.3	PK	356	1.0	RB 1 MHz; VB: 1 MHz

Note 1: Above 1 GHz, the FCC specifies the limit as an average measurement. In addition, the FCC states that the peak reading of any emission above 1 GHz, can not exceed the average limit by more than 20 dB.

Client:	Summit Data Communications	Job Number:	J74548
Model:	802.11abg Compact Flash Card	T-Log Number:	T74640
Contact:	Jerry Pohmurski	Account Manager:	Christine Krebill
Standard:	FCC 15.247/RSS 210	Class:	-

Run #4: Maximized readings, 1000 - 18000 MHz (802.11b with 3.8dBi Antenna (PCB), MAIN)

Date of Test: 2/23/2009
 Test Engineer:
 Test Location: SVOATS #1

Config. Used: 1
 Config Change: none
 Host Unit Voltage 120V/60Hz

Frequency MHz	Level dB μ V/m	Pol V/H	FCC Class B		Detector Pk/QP/Avg	Azimuth degrees	Height meters	Comments
			Limit	Margin				
1624.270	34.1	V	54.0	-19.9	AVG	356	1.0	RB 1 MHz; VB: 10 Hz
1626.170	25.1	H	54.0	-28.9	AVG	360	1.0	RB 1 MHz; VB: 10 Hz
3250.240	29.7	V	54.0	-24.3	AVG	360	1.0	RB 1 MHz; VB: 10 Hz
3250.740	29.7	H	54.0	-24.3	AVG	360	1.0	RB 1 MHz; VB: 10 Hz
4874.500	31.7	V	54.0	-22.3	AVG	356	1.0	RB 1 MHz; VB: 10 Hz
4875.200	31.8	H	54.0	-22.2	AVG	242	1.0	RB 1 MHz; VB: 10 Hz
6497.160	33.0	H	54.0	-21.0	AVG	62	1.0	RB 1 MHz; VB: 10 Hz
6497.170	33.0	V	54.0	-21.0	AVG	95	1.0	RB 1 MHz; VB: 10 Hz
7309.760	34.7	V	54.0	-19.3	AVG	356	1.0	RB 1 MHz; VB: 10 Hz
7310.580	34.8	H	54.0	-19.2	AVG	360	1.0	RB 1 MHz; VB: 10 Hz
1624.710	35.7	H	74.0	-38.3	PK	360	1.0	RB 1 MHz; VB: 1 MHz
1625.130	35.0	V	74.0	-39.0	PK	356	1.0	RB 1 MHz; VB: 1 MHz
3250.040	40.9	H	74.0	-33.1	PK	360	1.0	RB 1 MHz; VB: 1 MHz
3250.570	41.6	V	74.0	-32.4	PK	360	1.0	RB 1 MHz; VB: 1 MHz
4874.980	44.1	V	74.0	-29.9	PK	356	1.0	RB 1 MHz; VB: 1 MHz
4875.330	42.7	H	74.0	-31.3	PK	242	1.0	RB 1 MHz; VB: 1 MHz
6497.220	43.9	H	74.0	-30.1	PK	62	1.0	RB 1 MHz; VB: 1 MHz
6497.760	44.1	V	74.0	-29.9	PK	95	1.0	RB 1 MHz; VB: 1 MHz
7310.770	46.0	V	74.0	-28.0	PK	356	1.0	RB 1 MHz; VB: 1 MHz
7311.210	46.0	H	74.0	-28.0	PK	360	1.0	RB 1 MHz; VB: 1 MHz

Note 1: Above 1 GHz, the FCC specifies the limit as an average measurement. In addition, the FCC states that the peak reading of any emission above 1 GHz, can not exceed the average limit by more than 20 dB.

Client:	Summit Data Communications	Job Number:	J74548
Model:	802.11abg Compact Flash Card	T-Log Number:	T74640
Contact:	Jerry Pohmurski	Account Manager:	Christine Krebill
Standard:	FCC 15.247/RSS 210	Class:	-

Run #5: Maximized readings, 1000 - 18000 MHz (802.11a at 5200MHz with 5.0dBi Antenna (Larson), MAIN)

Date of Test: 3/4/2009
 Test Engineer: Mehran Birgani
 Test Location: SVOATS #1

Config. Used: 1
 Config Change: None
 Host Unit Voltage 120V/60Hz

Frequency MHz	Level dB μ V/m	Pol V/H	FCC Class B		Detector Pk/QP/Avg	Azimuth degrees	Height meters	Comments
			Limit	Margin				
5198.880	32.8	V	54.0	-21.2	AVG	330	1.0	
10400.750	38.1	V	54.0	-15.9	AVG	351	1.0	
10401.140	38.0	H	54.0	-16.0	AVG	310	1.0	
15598.480	40.1	H	54.0	-13.9	AVG	350	1.0	
15598.520	39.5	V	54.0	-14.5	AVG	300	1.0	
5198.571	43.7	V	74.0	-30.3	PK	330	1.0	
10399.240	48.9	H	74.0	-25.1	PK	310	1.0	
10400.200	49.4	V	74.0	-24.6	PK	351	1.0	
15599.250	50.7	H	74.0	-23.3	PK	350	1.0	
15599.360	51.0	V	74.0	-23.0	PK	300	1.0	

Run #6: Maximized readings, 1000 - 18000 MHz (802.11a at 5200MHz with 5.1dBi Antenna (PCB), MAIN)

Date of Test: 3/4/2009
 Test Engineer: Mehran Birgani
 Test Location: SVOATS #1

Config. Used: 1
 Config Change: None
 Host Unit Voltage 120V/60Hz

Frequency MHz	Level dB μ V/m	Pol V/H	FCC Class B		Detector Pk/QP/Avg	Azimuth degrees	Height meters	Comments
			Limit	Margin				
5199.000	32.2	V	54.0	-21.8	AVG	30	1.0	
10400.800	38.3	V	54.0	-15.7	AVG	81	1.0	
10401.130	37.9	H	54.0	-16.1	AVG	10	1.0	
15598.500	39.5	H	54.0	-14.5	AVG	355	1.0	
15598.520	39.6	V	54.0	-14.4	AVG	0	1.0	
5198.580	43.8	V	74.0	-30.2	PK	30	1.0	
10399.250	49.5	H	74.0	-24.5	PK	10	1.0	
10400.210	49.2	V	74.0	-24.8	PK	81	1.0	
15599.240	50.5	H	74.0	-23.5	PK	355	1.0	
15599.370	50.6	V	74.0	-23.4	PK	0	1.0	

Client:	Summit Data Communications	Job Number:	J74548
Model:	802.11abg Compact Flash Card	T-Log Number:	T74640
		Account Manager:	Christine Krebill
Contact:	Jerry Pohmurski		
Standard:	FCC 15.247/RSS 210	Class:	-

Run #7: Maximized readings, 1000 - 18000 MHz (802.11a at 5785MHz with 5.0dBi Antenna (Larson), MAIN)

Date of Test: 3/4/2009
 Test Engineer: Mehran Birgani
 Test Location: SVOATS #1

Config. Used: 1
 Config Change: None
 Host Unit Voltage 120V/60Hz

Frequency MHz	Level dBµV/m	Pol V/H	FCC Class B		Detector Pk/QP/Avg	Azimuth degrees	Height meters	Comments
			Limit	Margin				
5785.150	38.8	V	54.0	-15.2	AVG	59	2.0	
5785.170	40.1	H	54.0	-13.9	AVG	56	1.6	
11568.510	38.8	H	54.0	-15.2	AVG	318	1.0	
11568.520	38.7	V	54.0	-15.3	AVG	56	1.0	
17353.540	45.0	V	54.0	-9.0	AVG	305	1.3	
5785.110	48.4	H	74.0	-25.6	PK	56	1.6	
5785.160	46.7	V	74.0	-27.3	PK	59	2.0	
11570.210	49.3	H	74.0	-24.7	PK	318	1.0	
11571.060	49.9	V	74.0	-24.1	PK	56	1.0	
17354.610	56.3	V	74.0	-17.7	PK	305	1.3	

Run #8: Maximized readings, 1000 - 18000 MHz (802.11a at 5785MHz with 4.5dBi Antenna (PCB), MAIN)

Date of Test: 3/4/2009
 Test Engineer: Mehran Birgani
 Test Location: SVOATS #1

Config. Used: 1
 Config Change: None
 Host Unit Voltage 120V/60Hz

Frequency MHz	Level dBµV/m	Pol V/H	FCC Class B		Detector Pk/QP/Avg	Azimuth degrees	Height meters	Comments
			Limit	Margin				
5785.150	38.8	V	54.0	-15.2	AVG	159	2.0	
5785.170	40.1	H	54.0	-13.9	AVG	156	1.6	
11568.500	38.8	H	54.0	-15.2	AVG	18	1.0	
11568.500	38.7	V	54.0	-15.3	AVG	156	1.0	
17353.500	45.0	V	54.0	-9.0	AVG	5	1.3	
5785.090	48.4	H	74.0	-25.6	PK	156	1.6	
5785.150	46.7	V	74.0	-27.3	PK	159	2.0	
11570.210	49.3	H	74.0	-24.7	PK	18	1.0	
11571.040	49.9	V	74.0	-24.1	PK	156	1.0	
17354.620	56.3	V	74.0	-17.7	PK	5	1.3	



EMC Test Data

Client:	Summit Data Communications	Job Number:	J74548
Model:	802.11abg Compact Flash Card	T-Log Number:	T74640
		Account Manager:	Christine Krebill
Contact:	Jerry Pohmurski		
Emissions Standard(s):	FCC 15.247/RSS 210	Class:	-
Immunity Standard(s):	-	Environment:	-

EMC Test Data

For The

Summit Data Communications

Model

802.11abg Compact Flash Card

Date of Last Test: 3/10/2009



EMC Test Data

Client:	Summit Data Communications	Job Number:	J74548
Model:	802.11abg Compact Flash Card	T-Log Number:	T74640
Contact:	Jerry Pohmurski	Account Manger:	Christine Krebill
Emissions Standard(s):	FCC 15.247/RSS 210	Class:	-
Immunity Standard(s):	-	Environment:	-

EUT INFORMATION

**The following information was collected during the test session(s).
The client agreed to provide the following information after the test session(s).**

General Description

The EUT is a 802.11ag compliant wireless LAN radio Module which is designed to provide wireless local area networking connectivity. Normally, the EUT would be embedded in various types of mobile and stationary computing devices such as handheld and vehicle mounted data terminals during operation. The EUT was, therefore, placed in this position during emissions testing to simulate the end user environment. The electrical rating of the EUT is 3.3 VDC \pm 5%. It's typical power consumption is 400mA (1320mW) while in transmit mode, 180mA (594mW) while in receive mode and 10mA (33mW) while in standby mode.

Equipment Under Test

Manufacturer	Model	Description	Serial Number	FCC ID
Summit Data Communications Inc.	MCF10AG	802.11AG Mini Compact Flash Module with antenna connectors		TWG-SDCMCF10AG

EUT Antenna (Intentional Radiators Only)

The antenna connects to the EUT via a standard u.f1 antenna connector, thereby meeting the requirements of FCC 15.203.

There were two antennas included in the testing:

Laird Centurion, m/n NanoBlade, pcb antenna, 3.8dBi @ 2.45GHz, 5.1dBi @ 5.25GHz, 4.5dBi @ 5.8GHz

Larson, p/n R380.500.314, Omni, 1.6dBi @ 2.4GHz, 5dBi @ 5GHz

EUT Enclosure

The EUT does not have an enclosure as it is designed to be installed within the enclosure of a host computer or system.

Modification History

Mod. #	Test	Date	Modification
1			No modifications were made to the EUT during testing.
2			
3			

Modifications applied are assumed to be used on subsequent tests unless otherwise stated as a further modification.



EMC Test Data

Client:	Summit Data Communications	Job Number:	J74548
Model:	802.11abg Compact Flash Card	T-Log Number:	T74640
		Account Manger:	Christine Krebill
Contact:	Jerry Pohmurski		
Emissions Standard(s):	FCC 15.247/RSS 210	Class:	-
Immunity Standard(s):	-	Environment:	-

Test Configuration #1

The following information was collected during the test session(s).

Local Support Equipment

Manufacturer	Model	Description	Serial Number	FCC ID
Hewlett Packard	iPAQ	Handheld Computer	-	-

Remote Support Equipment

Manufacturer	Model	Description	Serial Number	FCC ID
None	-	-	-	-

Cabling and Ports

Port	Connected To	Cable(s)		
		Description	Shielded or Unshielded	Length(m)
iPAQ Power	AC Mains	2wire	Unshielded	1.5
Flash Module	iPAQ Module Port	-	-	-

EUT Operation During Emissions Tests

During emissions testing the EUT was configured to transmit at the Low, Middle, and High Channel. Testing performed at 1Mbps for 802.11b mode, and 6Mbps for 802.11g and 802.11a modes.

Client:	Summit Data Communications	Job Number:	J74548
Model:	802.11abg Compact Flash Card	T-Log Number:	T74640
		Account Manager:	Christine Krebill
Contact:	Jerry Pohmurski		
Standard:	FCC 15.247/RSS 210	Class:	N/A

RSS 210 and FCC 15.247 (DTS) Antenna Port Measurements Power, PSD, Bandwidth and Spurious Emissions

Test Specific Details

Objective: The objective of this test session is to perform final qualification testing of the EUT with respect to the specification listed above.

Date of Test: 3/5/2009	Config. Used: 1
Test Engineer: Suhaila Khushzad	Config Change: None
Test Location: SVOATS #1	EUT Voltage: 120V/60Hz

General Test Configuration

The EUT was connected to the spectrum analyzer or power meter via a suitable attenuator. All measurements were made on a single chain.

All measurements have been corrected to allow for the external attenuators used.

Ambient Conditions:

Temperature:	10.6 °C
Rel. Humidity:	76 %

Summary of Results

Run #	Pwr setting	Avg Pwr	Test Performed	Limit	Pass / Fail	Result / Margin
1	100%	-	Output Power	15.247(b)	Pass	17.9 dBm(61.5mW)
2	100%	-	Power spectral Density (PSD)	15.247(d)	Pass	7.83 dBm/3kHz
3	100%	-	Minimum 6dB Bandwidth	15.247(a)	Pass	10.167 MHz
3	100%	-	99% Bandwidth	RSS GEN	-	13.23 MHz
4	100%	-	Spurious emissions	15.247(b)	Pass	All emissions below the -30dBc limit

Modifications Made During Testing

No modifications were made to the EUT during testing

Deviations From The Standard

No deviations were made from the requirements of the standard.

Client: Summit Data Communications	Job Number: J74548
Model: 802.11abg Compact Flash Card	T-Log Number: T74640
	Account Manager: Christine Krebill
Contact: Jerry Pohmurski	
Standard: FCC 15.247/RSS 210	Class: N/A

Run #1: Output Power

Power Setting ²	Frequency (MHz)	Output Power		Antenna Gain (dBi)	Result	EIRP ^{Note 2}		Output Power	
		(dBm) ¹	mW			dBm	W	(dBm) ³	mW
100%	2412	16.8	47.9	3.8	Pass	20.6	0.115		
100%	2437	17.9	61.5	3.8	Pass	21.7	0.148		
100%	2462	17.3	53.6	3.8	Pass	21.1	0.129		

Note 1: Output power measured using a spectrum analyzer (see plots below):
 RBW=1MHz, VB=3 MHz, sample detector, power averaging on (transmitted signal was continuous) and power integration over 50 MHz. **Spurious limit is -30dBc because this method was used.**

Note 2: Power setting - the software power setting used during testing, included for reference only.

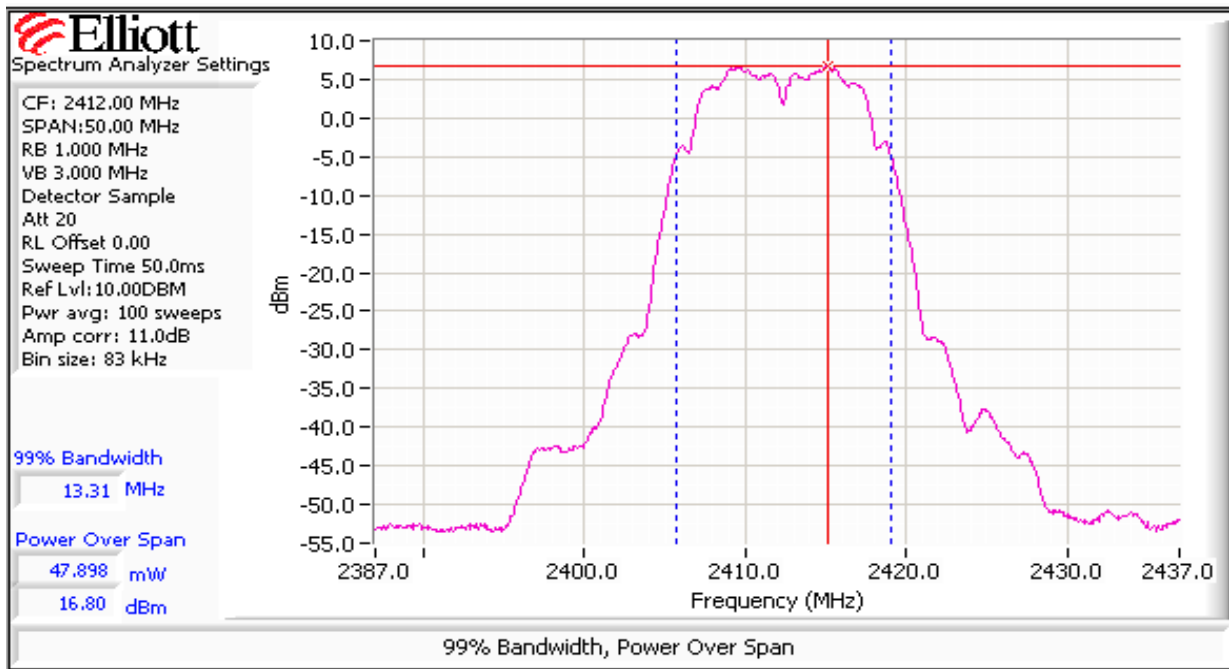

Client: Summit Data Communications	Job Number: J74548
Model: 802.11abg Compact Flash Card	T-Log Number: T74640
	Account Manager: Christine Krebill
Contact: Jerry Pohmurski	
Standard: FCC 15.247/RSS 210	Class: N/A

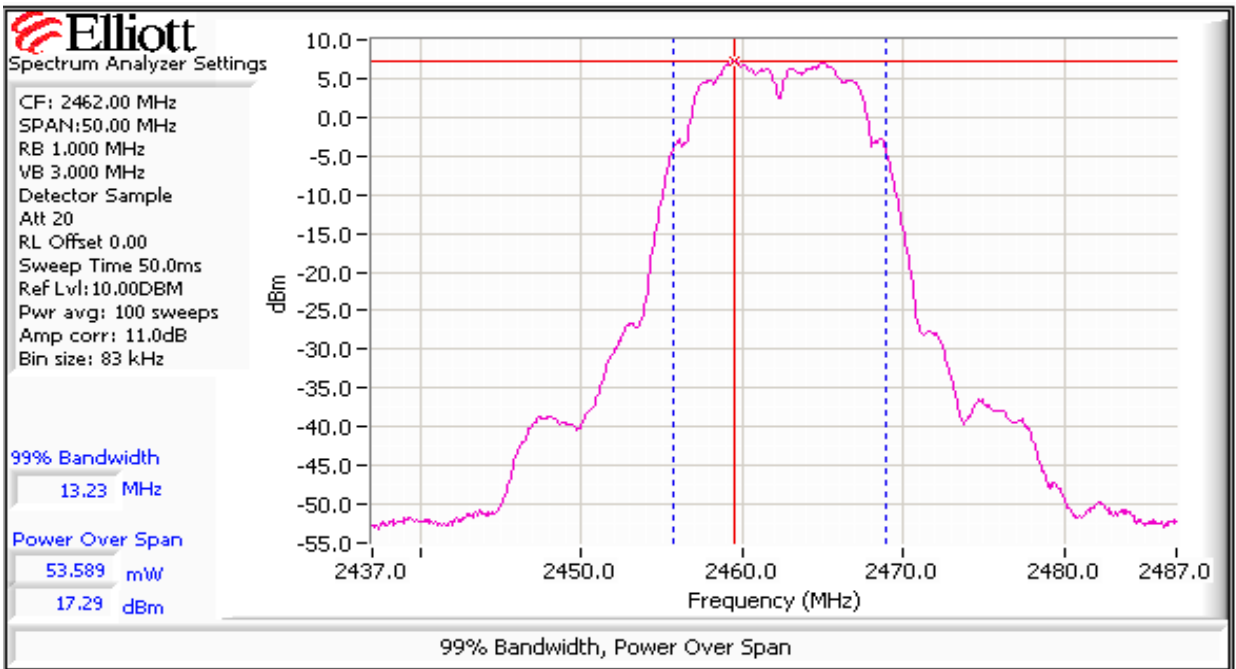
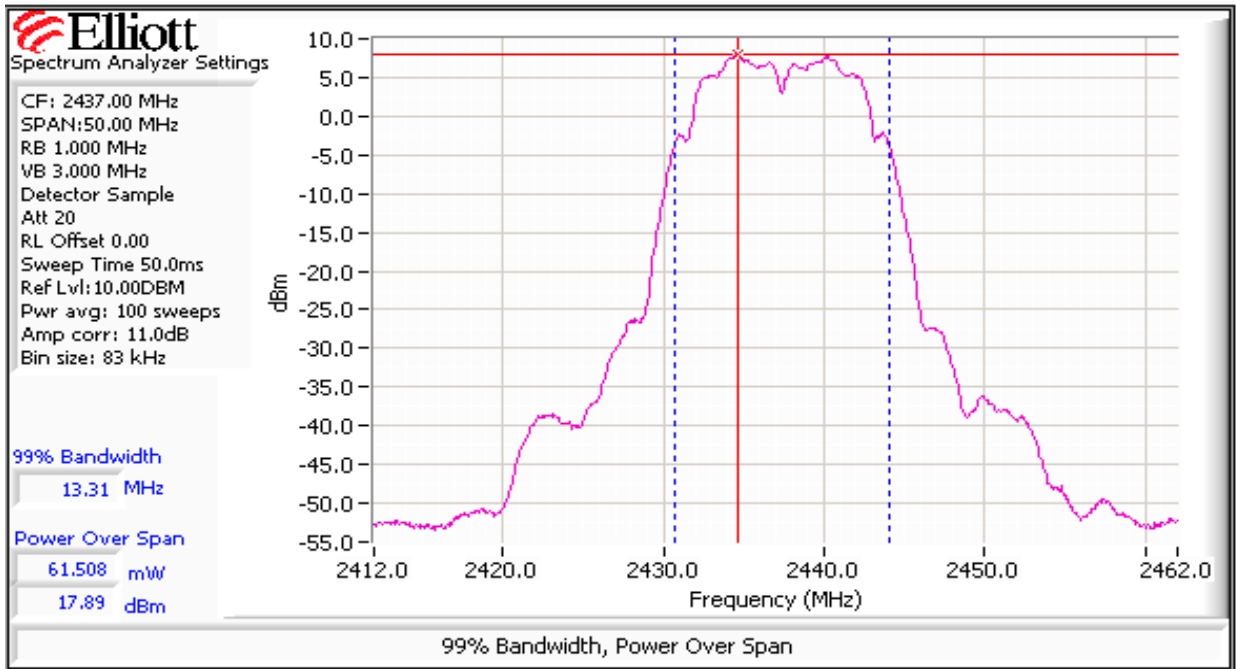

Client: Summit Data Communications	Job Number: J74548
Model: 802.11abg Compact Flash Card	T-Log Number: T74640
	Account Manager: Christine Krebill
Contact: Jerry Pohmurski	
Standard: FCC 15.247/RSS 210	Class: N/A

Run #2: Power spectral Density

Power Setting	Frequency (MHz)	PSD	Limit dBm/3kHz	Result
		(dBm/3kHz) <small>Note 1</small>		
100%	2412	7.8	8.0	Pass
100%	2437	4.2	8.0	Pass
100%	2462	-4.5	8.0	Pass

Note 1: Power spectral density measured using RB=3 kHz, VB=10kHz, analyzer with peak detector and with a sweep time set to ensure a dwell time of at least 1 second per 3kHz. The measurement is made at the frequency of PPSD determined from preliminary scans using RB=3kHz using multiple sweeps at a faster rate over the 6dB bandwidth of the signal.

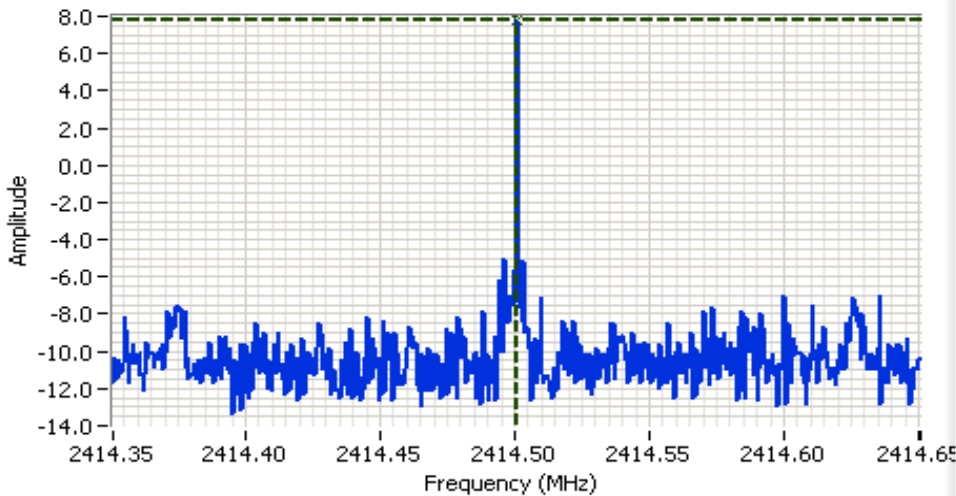

Analyzer Settings

HP8564E
 CF: 2414.501 MHz
 SPAN: 300 kHz
 RB 3.00 kHz
 VB 10.00 kHz
 Detector POS
 Att 20
 RL Offset 11.00
 Sweep Time 100.0s
 Ref Lvl: 21.00DBM

Comments

PSD: 7.83dB/3kHz

Cursor 1	2414.5007	7.83	
	0.0000	0.00	



Client: Summit Data Communications	Job Number: J74548
Model: 802.11abg Compact Flash Card	T-Log Number: T74640
	Account Manager: Christine Krebill
Contact: Jerry Pohmurski	
Standard: FCC 15.247/RSS 210	Class: N/A

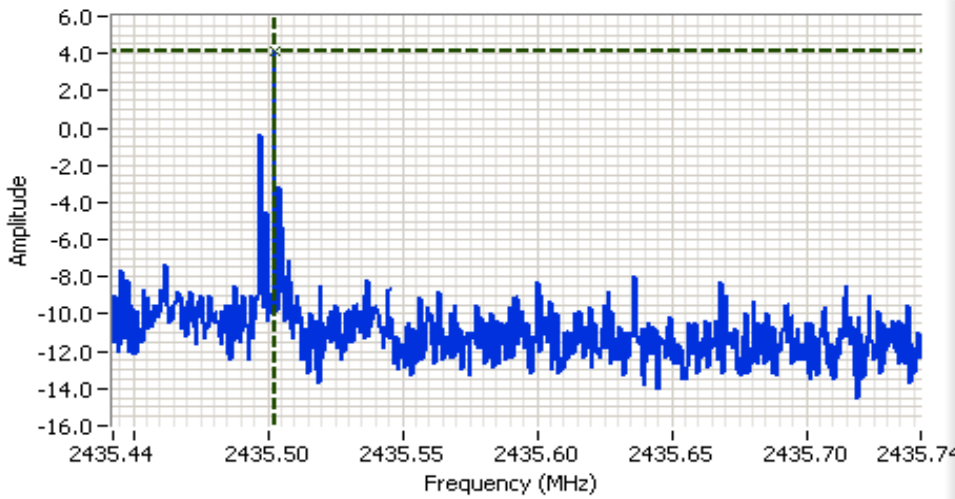

Analyzer Settings

HP8564E
 CF: 2435.593 MHz
 SPAN: 300 kHz
 RB 3.00 kHz
 VB 10.00 kHz
 Detector POS
 Att 20
 RL Offset 11.00
 Sweep Time 100.0s
 Ref Lvl: 21.00DBM

Comments

PSD: 4.17dB/3kHz

Cursor 1 2435.5025 4.17

0.0000 0.00

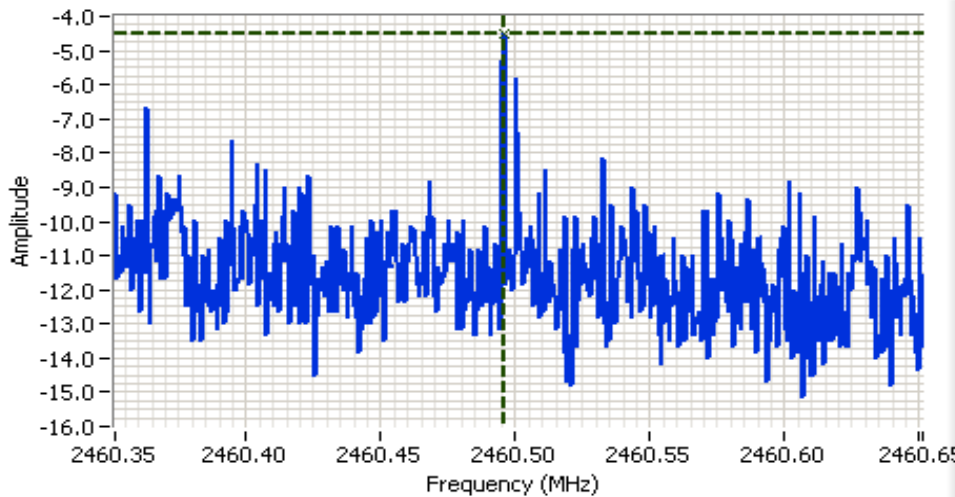

Analyzer Settings

HP8564E
 CF: 2460.501 MHz
 SPAN: 300 kHz
 RB 3.00 kHz
 VB 10.00 kHz
 Detector POS
 Att 20
 RL Offset 11.00
 Sweep Time 100.0s
 Ref Lvl: 21.00DBM

Comments

PSD: -4.50B/3kHz

Cursor 1 2460.4957 -4.50

0.0000 0.00



Client: Summit Data Communications	Job Number: J74548
Model: 802.11abg Compact Flash Card	T-Log Number: T74640
	Account Manager: Christine Krebill
Contact: Jerry Pohmurski	
Standard: FCC 15.247/RSS 210	Class: N/A

Run #3: Signal Bandwidth

Power Setting	Frequency (MHz)	Resolution Bandwidth	Bandwidth (MHz)	
			6dB	99%
100%	2412	100kHz	10.33	13.31
100%	2437	100kHz	10.17	13.31
100%	2462	100kHz	10.25	13.23

Note 1: 99% bandwidth measured in accordance with RSS GEN, with RB > 1% of the span and VB > 3xRB



Analyzer Settings

HP8564E
 CF: 2412.000 MHz
 SPAN: 50.000 MHz
 RB 100 kHz
 VB 100 kHz
 Detector POS
 Att 20
 RL Offset 11.00
 Sweep Time 50.0ms
 Ref Lvl: 21.00DBM

Comments

6dB BW: 10.333 MHz

Cursor 1	2417.5833	5.33	
Cursor 2	2407.2500	-0.67	

Delta Freq. 10.333
 Delta Amplitude 6.00



Client: Summit Data Communications	Job Number: J74548
Model: 802.11abg Compact Flash Card	T-Log Number: T74640
Contact: Jerry Pohmurski	Account Manager: Christine Krebill
Standard: FCC 15.247/RSS 210	Class: N/A

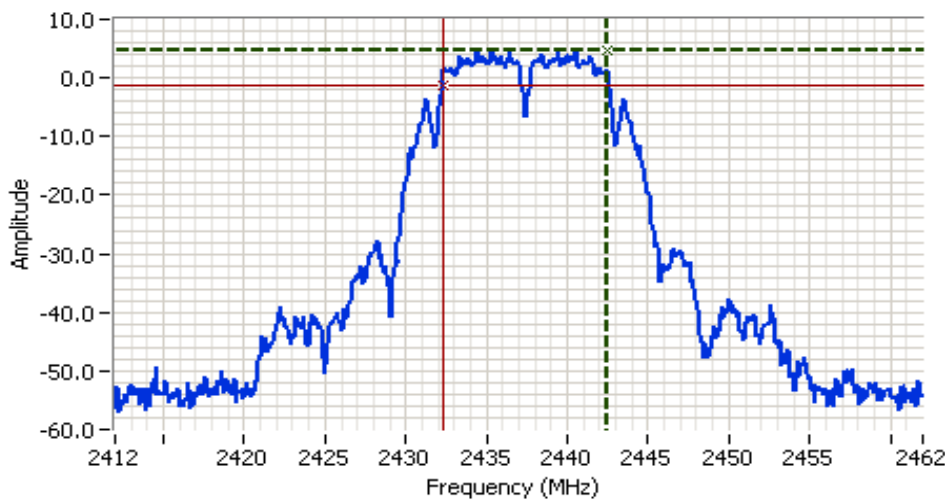

Analyzer Settings

HP8564E
 CF: 2437.000 MHz
 SPAN:50.000 MHz
 RB 100 kHz
 VB 100 kHz
 Detector POS
 Att 20
 RL Offset 11.00
 Sweep Time 50.0ms
 Ref Lvl:21.00DBM

Comments

6dB BW: 10.167 MHz

Cursor 1 2442.5000 4.67

Cursor 2 2432.3333 -1.33

Delta Freq. 10.167

Delta Amplitude 6.00

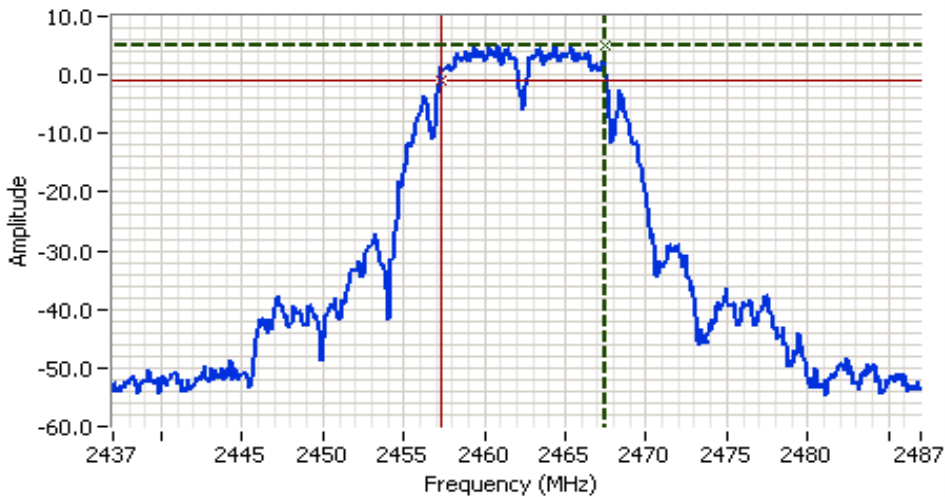

Analyzer Settings

HP8564E
 CF: 2462.000 MHz
 SPAN:50.000 MHz
 RB 100 kHz
 VB 100 kHz
 Detector POS
 Att 20
 RL Offset 11.00
 Sweep Time 50.0ms
 Ref Lvl:21.00DBM

Comments

6dB BW: 10.250 MHz

Cursor 1 2467.5000 5.17

Cursor 2 2457.2500 -0.83

Delta Freq. 10.250

Delta Amplitude 6.00



Client: Summit Data Communications	Job Number: J74548
Model: 802.11abg Compact Flash Card	T-Log Number: T74640
	Account Manager: Christine Krebill
Contact: Jerry Pohmurski	
Standard: FCC 15.247/RSS 210	Class: N/A

Run #4: Out of Band Spurious Emissions

Frequency (MHz)	Limit	Result
2412	-30dBc	Pass
2437	-30dBc	Pass
2462	-30dBc	Pass

Plots for low channel, power setting(s) = 100 %

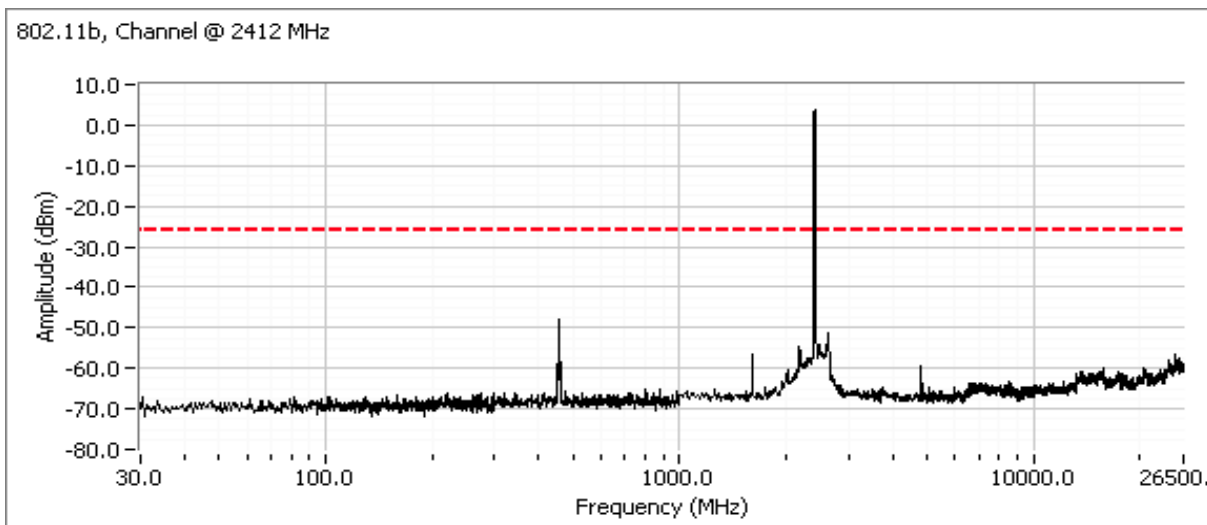

Additional plot showing compliance with -30dBc limit from 2390 MHz to 2400 MHz. Radiated measurements used to show compliance with the limits in the restricted band below 2390 MHz.

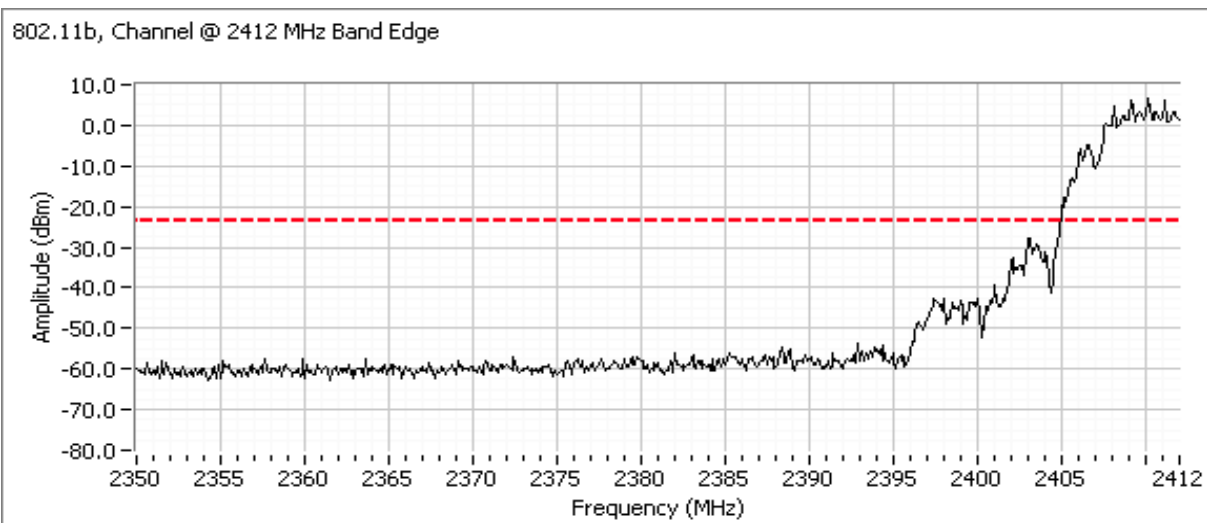

Client: Summit Data Communications	Job Number: J74548
Model: 802.11abg Compact Flash Card	T-Log Number: T74640
	Account Manager: Christine Krebill
Contact: Jerry Pohmurski	
Standard: FCC 15.247/RSS 210	Class: N/A

Plots for center channel, power setting(s) = 100 %

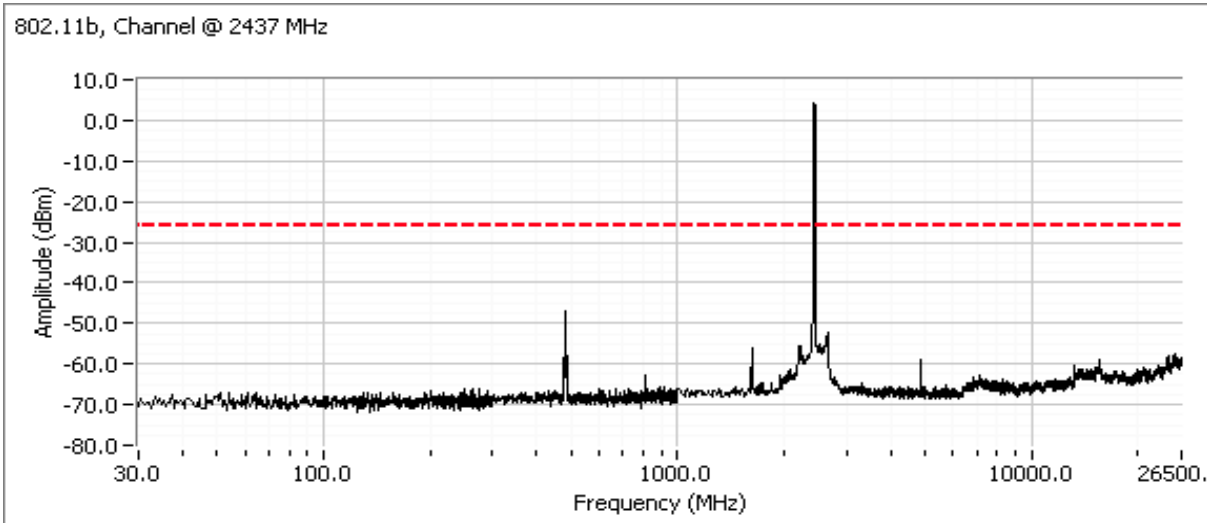

Plots for high channel, power setting(s) = 100 %

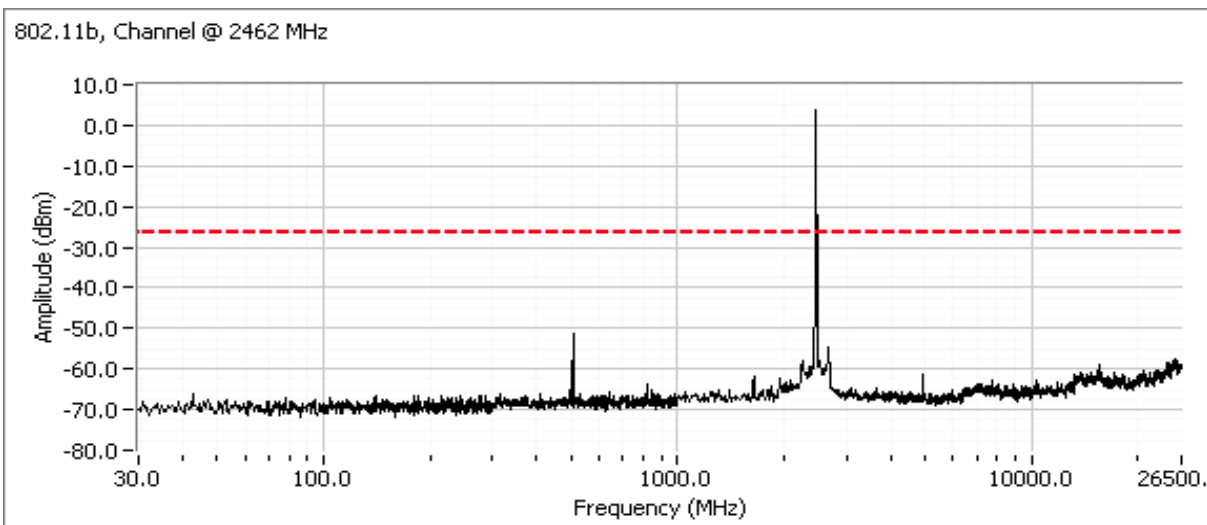

Client:	Summit Data Communications	Job Number:	J74548
Model:	802.11abg Compact Flash Card	T-Log Number:	T74640
Contact:	Jerry Pohmurski	Account Manager:	Christine Krebill
Standard:	FCC 15.247/RSS 210	Class:	N/A

Additional plot from 2483.5 - 2500 MHz showing compliance with -30dBc at the band edge.

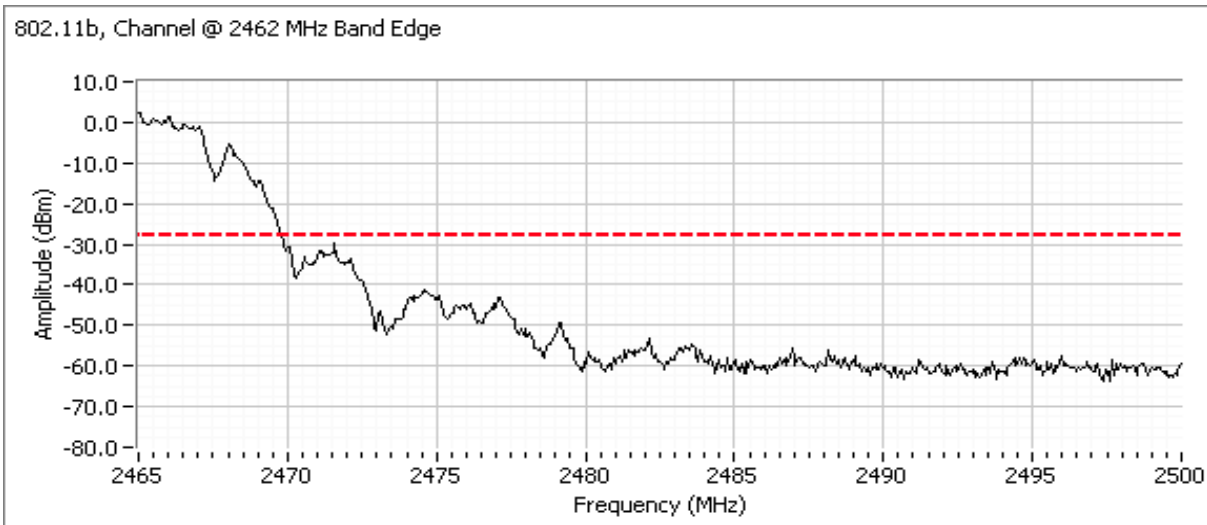

Client:	Summit Data Communications	Job Number:	J74548
Model:	802.11abg Compact Flash Card	T-Log Number:	T74640
		Account Manager:	Christine Krebill
Contact:	Jerry Pohmurski		
Standard:	FCC 15.247/RSS 210	Class:	N/A

RSS 210 and FCC 15.247 (DTS) Antenna Port Measurements Power, PSD, Bandwidth and Spurious Emissions

Test Specific Details

Objective: The objective of this test session is to perform final qualification testing of the EUT with respect to the specification listed above.

Date of Test: 3/5/2009	Config. Used: 1
Test Engineer: Suhaila Khushzad	Config Change: None
Test Location: SVOATS #1	EUT Voltage: 120V/60Hz

General Test Configuration

The EUT was connected to the spectrum analyzer or power meter via a suitable attenuator. All measurements were made on a single chain.

All measurements have been corrected to allow for the external attenuators used.

Ambient Conditions: Temperature: 10.6 °C
 Rel. Humidity: 76 %

Summary of Results

Run #	Pwr setting	Avg Pwr	Test Performed	Limit	Pass / Fail	Result / Margin
1	100%	-	Output Power	15.247(b)	Pass	13.5 dBm(22.4mW)
2	100%	-	Power spectral Density (PSD)	15.247(d)	Pass	-13.5 dBm/3kHz
3	100%	-	Minimum 6dB Bandwidth	15.247(a)	Pass	16.5 MHz
3	100%	-	99% Bandwidth	RSS GEN	-	17.5 MHz
4	100%	-	Spurious emissions	15.247(b)	Pass	All emissions below the -30dBc limit

Modifications Made During Testing

No modifications were made to the EUT during testing

Deviations From The Standard

No deviations were made from the requirements of the standard.

Client:	Summit Data Communications	Job Number:	J74548
Model:	802.11abg Compact Flash Card	T-Log Number:	T74640
Contact:	Jerry Pohmurski	Account Manager:	Christine Krebill
Standard:	FCC 15.247/RSS 210	Class:	N/A

Run #1: Output Power

Power Setting ²	Frequency (MHz)	Output Power		Antenna Gain (dBi)	Result	EIRP ^{Note 2}		Output Power	
		(dBm) ¹	mW			dBm	W	(dBm) ³	mW
100%	2412	13.2	21.1	3.8	Pass	17.0	0.051		
100%	2437	13.5	22.4	3.8	Pass	17.3	0.054		
100%	2462	12.8	19.1	3.8	Pass	16.6	0.046		

Note 1: Output power measured using a spectrum analyzer (see plots below):
 RBW=1MHz, VB=3 MHz, sample detector, power averaging on (transmitted signal was continuous) and power integration over 50 MHz. **Spurious limit is -30dBc because this method was used.**

Note 2: Power setting - the software power setting used during testing, included for reference only.

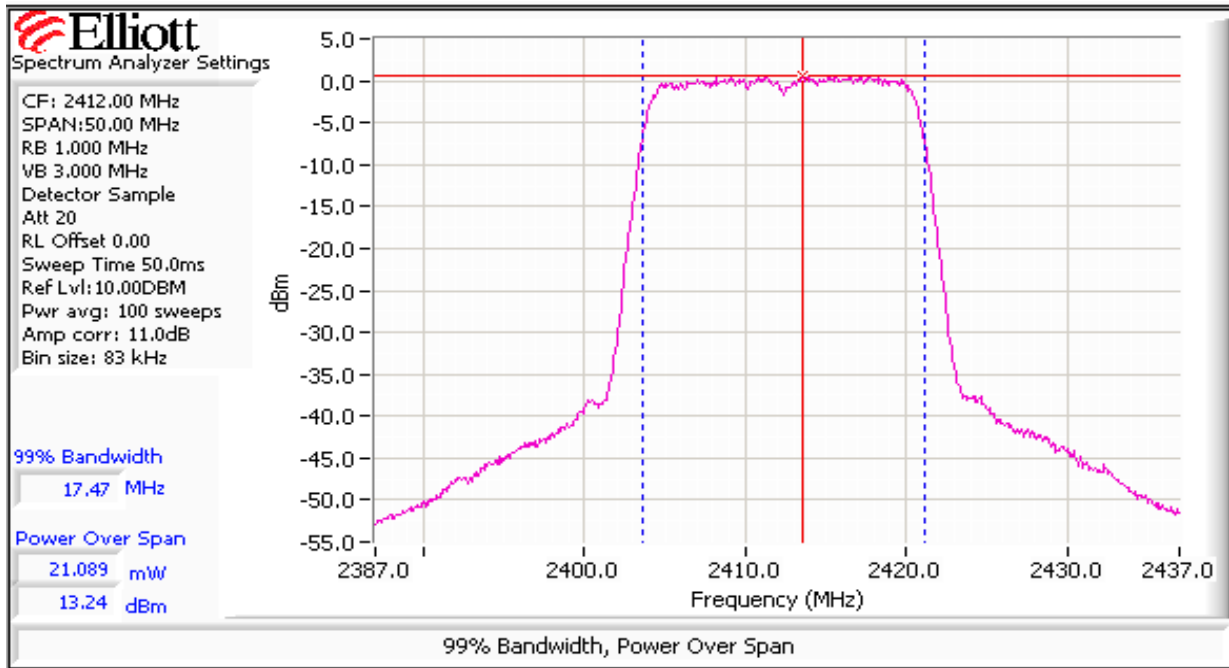

Client: Summit Data Communications	Job Number: J74548
Model: 802.11abg Compact Flash Card	T-Log Number: T74640
	Account Manager: Christine Krebill
Contact: Jerry Pohmurski	
Standard: FCC 15.247/RSS 210	Class: N/A

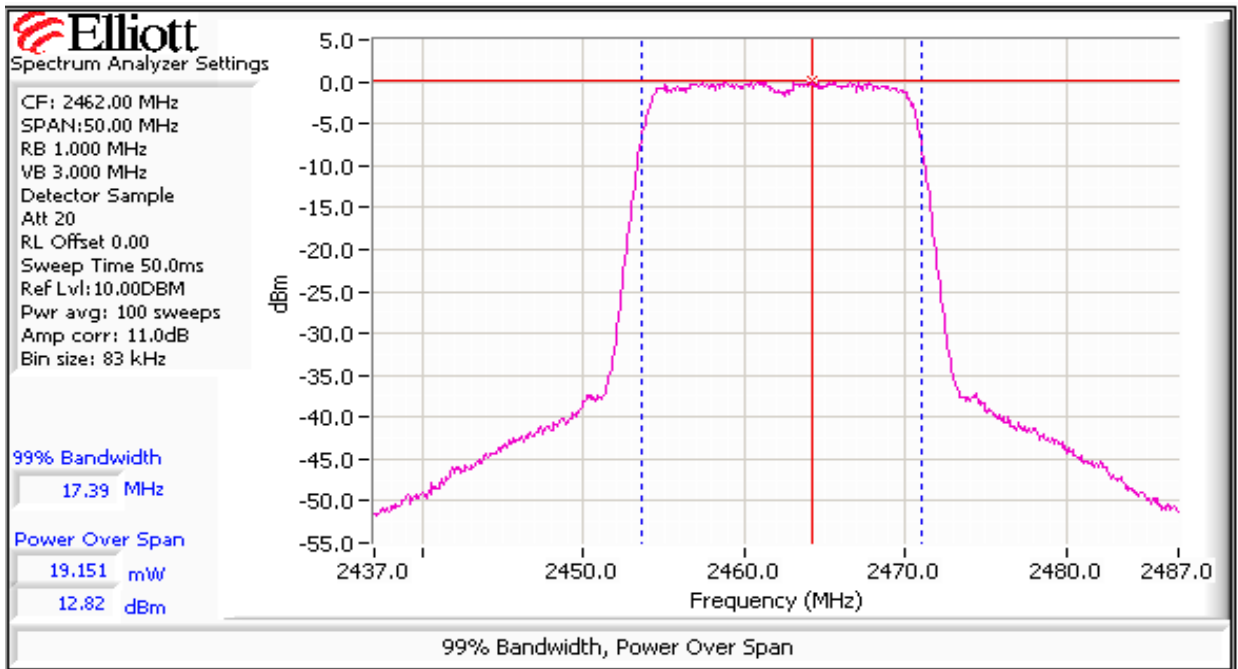
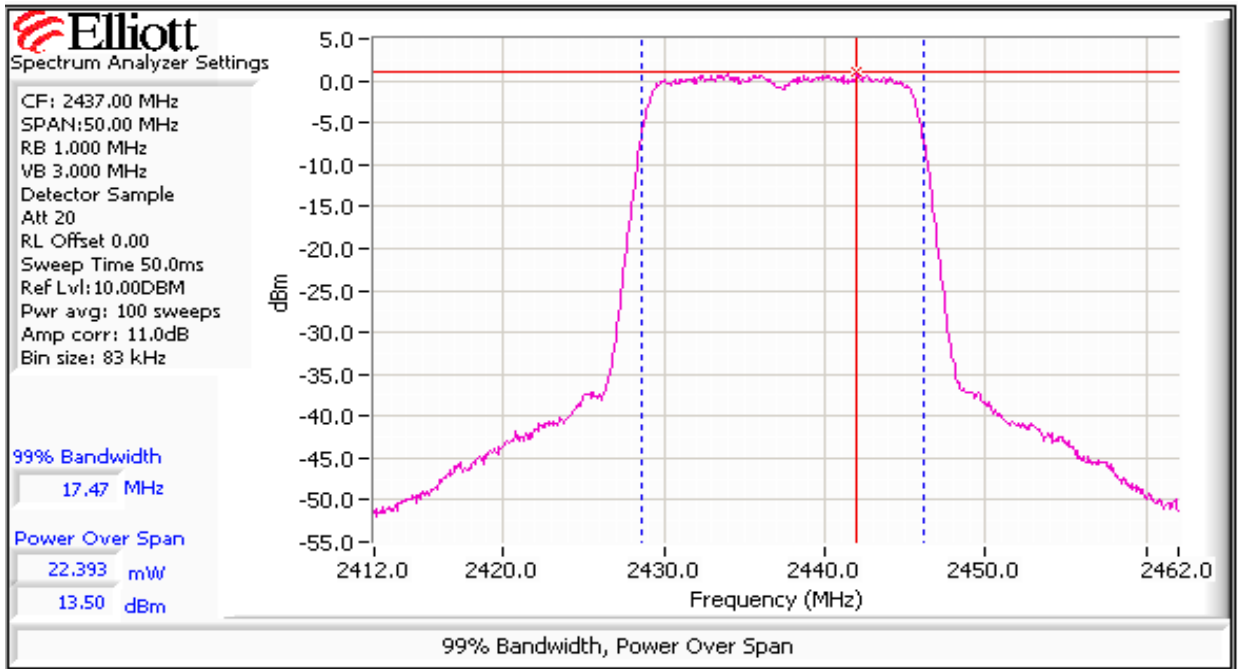

Client: Summit Data Communications	Job Number: J74548
Model: 802.11abg Compact Flash Card	T-Log Number: T74640
	Account Manager: Christine Krebill
Contact: Jerry Pohmurski	
Standard: FCC 15.247/RSS 210	Class: N/A

Run #2: Power spectral Density

Power Setting	Frequency (MHz)	PSD	Limit dBm/3kHz	Result
		(dBm/3kHz) <small>Note 1</small>		
100%	2412	-13.5	8.0	Pass
100%	2437	-14.8	8.0	Pass
100%	2462	-14.8	8.0	Pass

Note 1: Power spectral density measured using RB=3 kHz, VB=10kHz, analyzer with peak detector and with a sweep time set to ensure a dwell time of at least 1 second per 3kHz. The measurement is made at the frequency of PPSD determined from preliminary scans using

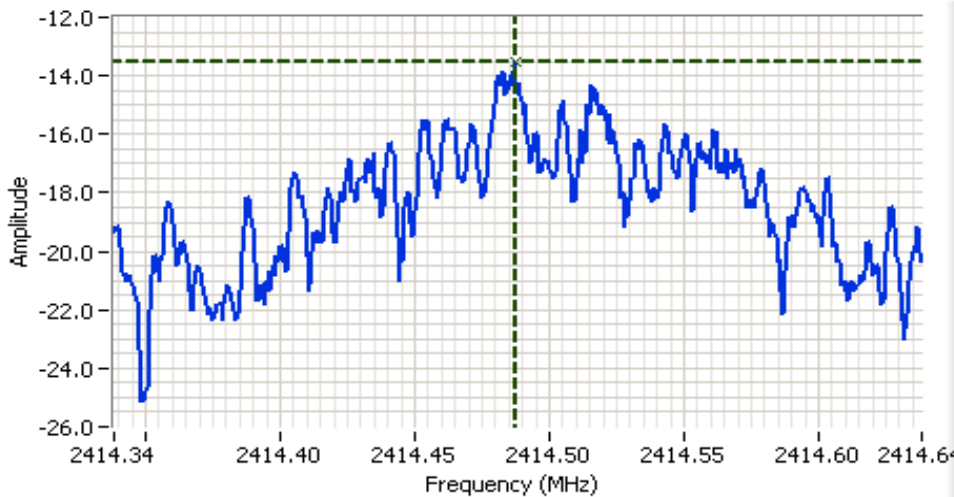



Analyzer Settings

HP8564E
 CF: 2414.488 MHz
 SPAN: 300 kHz
 RB 3.00 kHz
 VB 10.00 kHz
 Detector POS
 Att 20
 RL Offset 11.00
 Sweep Time 100.0s
 Ref Lvl: 21.00DBM

Comments

PSD: -13.50dB/3kHz

Cursor 1 2414.4873 -13.50 

 0.0000 0.00 

Client: Summit Data Communications	Job Number: J74548
Model: 802.11abg Compact Flash Card	T-Log Number: T74640
	Account Manager: Christine Krebill
Contact: Jerry Pohmurski	
Standard: FCC 15.247/RSS 210	Class: N/A

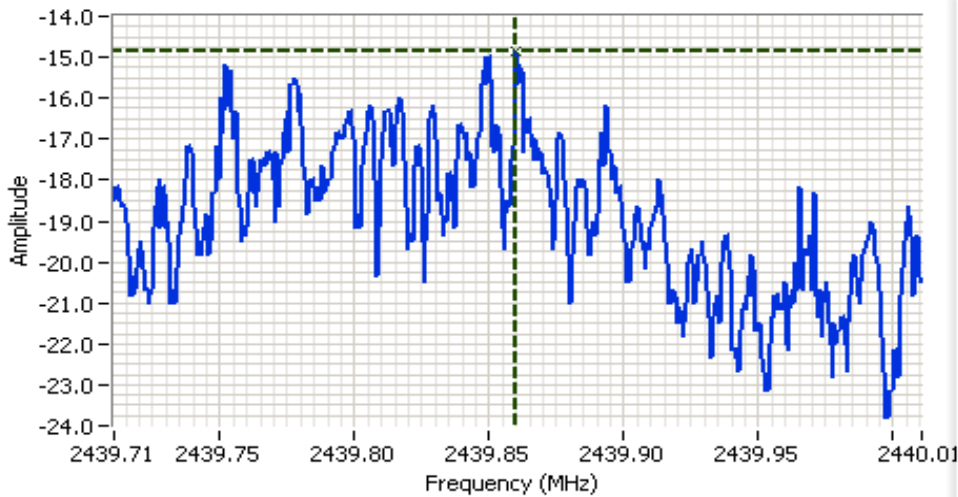

Analyzer Settings

HP8564E
 CF: 2439.861 MHz
 SPAN: 300 kHz
 RB 3.00 kHz
 VB 10.00 kHz
 Detector POS
 Att 20
 RL Offset 11.00
 Sweep Time 100.0s
 Ref Lvl: 21.00DBM

Comments

PSD: -14.83dB/3kHz

Cursor 1 2439.8601 -14.83

0.0000 0.00

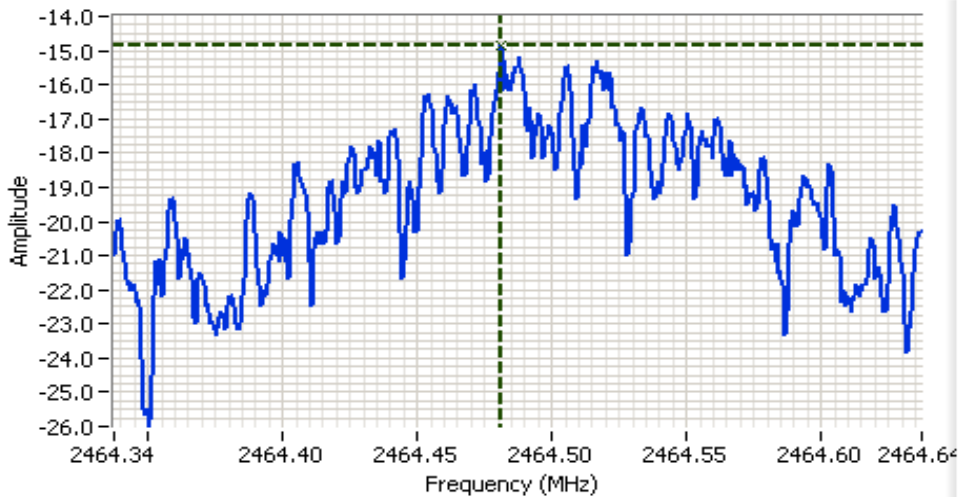

Analyzer Settings

HP8564E
 CF: 2464.487 MHz
 SPAN: 300 kHz
 RB 3.00 kHz
 VB 10.00 kHz
 Detector POS
 Att 20
 RL Offset 11.00
 Sweep Time 100.0s
 Ref Lvl: 21.00DBM

Comments

PSD: -14.83dB/3kHz

Cursor 1 2464.4813 -14.83

0.0000 0.00



Client: Summit Data Communications	Job Number: J74548
Model: 802.11abg Compact Flash Card	T-Log Number: T74640
	Account Manager: Christine Krebill
Contact: Jerry Pohmurski	
Standard: FCC 15.247/RSS 210	Class: N/A

Run #3: Signal Bandwidth

Power Setting	Frequency (MHz)	Resolution Bandwidth	Bandwidth (MHz)	
			6dB	99%
100%	2412	100kHz	16.58	17.47
100%	2437	100kHz	16.58	17.47
100%	2462	100kHz	16.5	17.39

Note 1: 99% bandwidth measured in accordance with RSS GEN, with RB > 1% of the span and VB > 3xRB

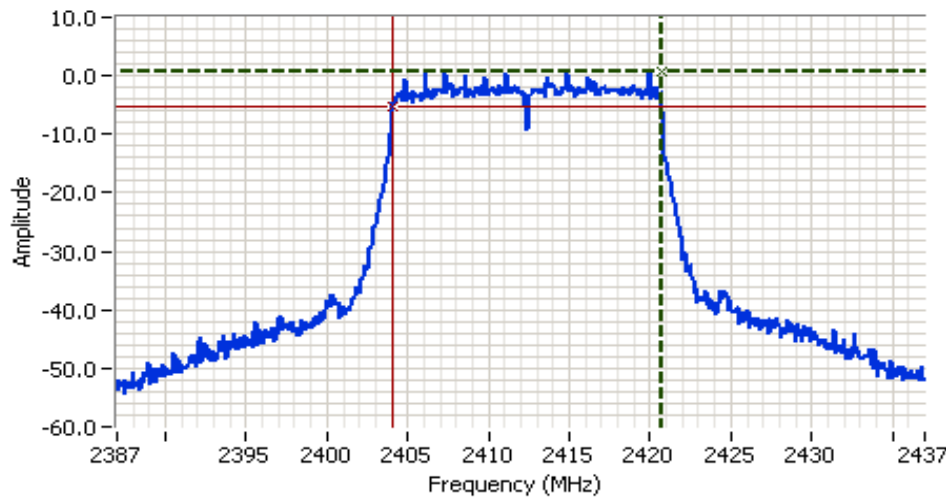

Analyzer Settings

HP8564E
 CF: 2412.000 MHz
 SPAN:50.000 MHz
 RB 100 kHz
 VB 100 kHz
 Detector POS
 Att 20
 RL Offset 11.00
 Sweep Time 50.0ms
 Ref Lvl:21.00DBM

Comments

6dB BW: 16.583 MHz

Cursor 1	2420.6667	0.67		Delta Freq.	16.583
Cursor 2	2404.0833	-5.33		Delta Amplitude	6.00



Client: Summit Data Communications	Job Number: J74548
Model: 802.11abg Compact Flash Card	T-Log Number: T74640
Contact: Jerry Pohmurski	Account Manager: Christine Krebill
Standard: FCC 15.247/RSS 210	Class: N/A

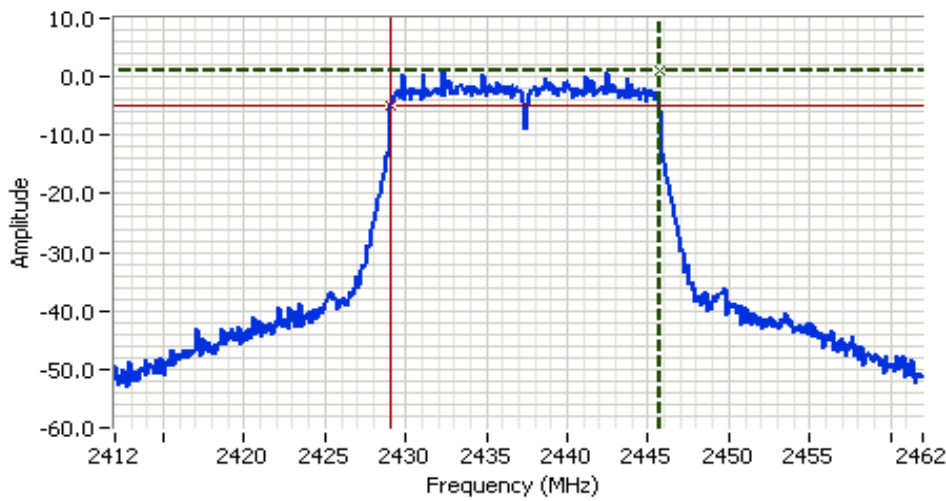

Analyzer Settings

HP8564E
 CF: 2437.000 MHz
 SPAN: 50.000 MHz
 RB 100 kHz
 VB 100 kHz
 Detector POS
 Att 20
 RL Offset 11.00
 Sweep Time 50.0ms
 Ref Lvl: 21.00DBM

Comments

6dB BW: 16.583 MHz

Cursor 1 2445.6667 1.17

Cursor 2 2429.0833 -4.83

Delta Freq. 16.583

Delta Amplitude 6.00

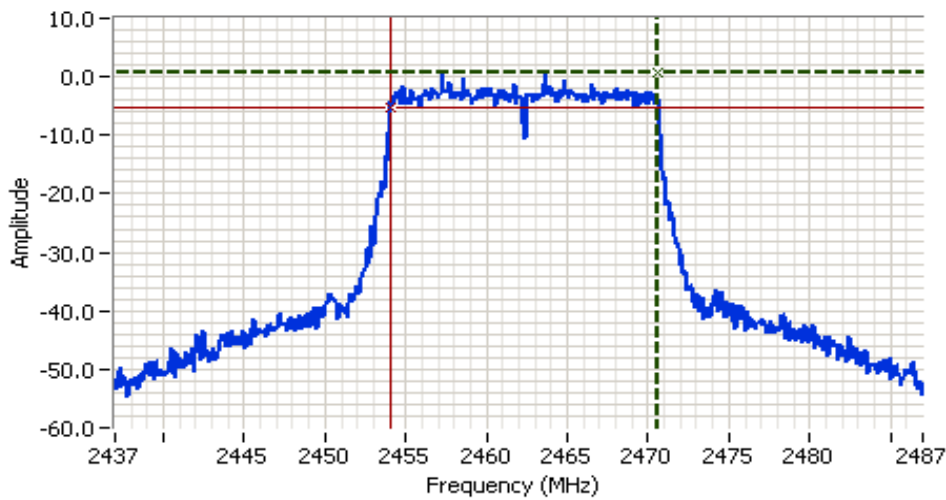

Analyzer Settings

HP8564E
 CF: 2462.000 MHz
 SPAN: 50.000 MHz
 RB 100 kHz
 VB 100 kHz
 Detector POS
 Att 20
 RL Offset 11.00
 Sweep Time 50.0ms
 Ref Lvl: 21.00DBM

Comments

6dB BW: 16.500 MHz

Cursor 1 2470.5833 0.67

Cursor 2 2454.0833 -5.33

Delta Freq. 16.500

Delta Amplitude 6.00



Client: Summit Data Communications	Job Number: J74548
Model: 802.11abg Compact Flash Card	T-Log Number: T74640
	Account Manager: Christine Krebill
Contact: Jerry Pohmurski	
Standard: FCC 15.247/RSS 210	Class: N/A

Run #4: Out of Band Spurious Emissions

Frequency (MHz)	Limit	Result
2412	-30dBc	Pass
2437	-30dBc	Pass
2462	-30dBc	Pass

Plots for low channel, power setting(s) = 100 %

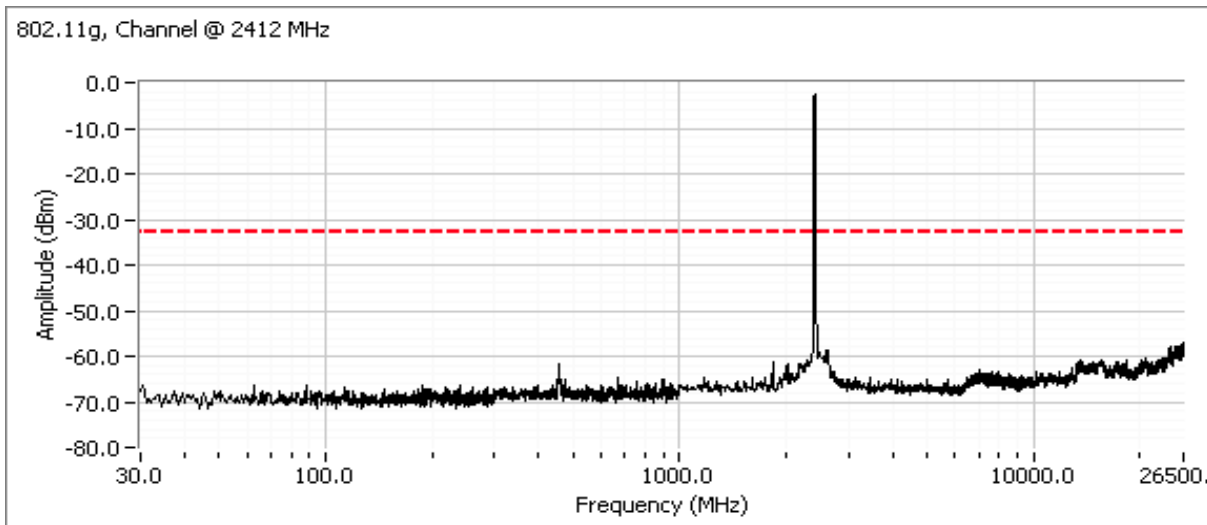

Additional plot showing compliance with -30dBc limit from 2390 MHz to 2400 MHz. Radiated measurements used to show compliance with the limits in the restricted band below 2390 MHz.

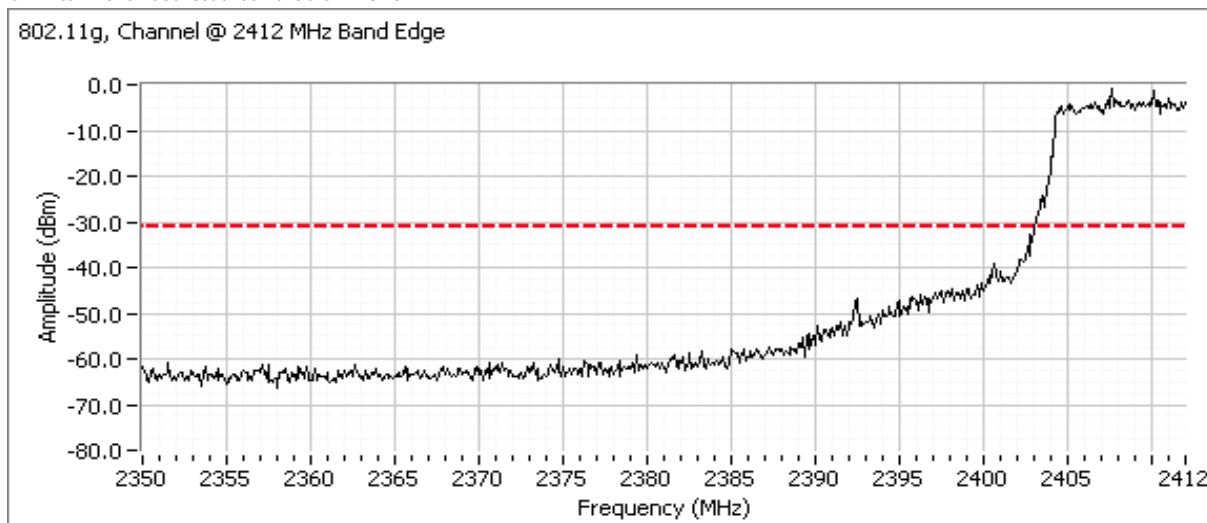

Client:	Summit Data Communications	Job Number:	J74548
Model:	802.11abg Compact Flash Card	T-Log Number:	T74640
Contact:	Jerry Pohmurski	Account Manager:	Christine Krebill
Standard:	FCC 15.247/RSS 210	Class:	N/A

Plots for center channel, power setting(s) = 100 %

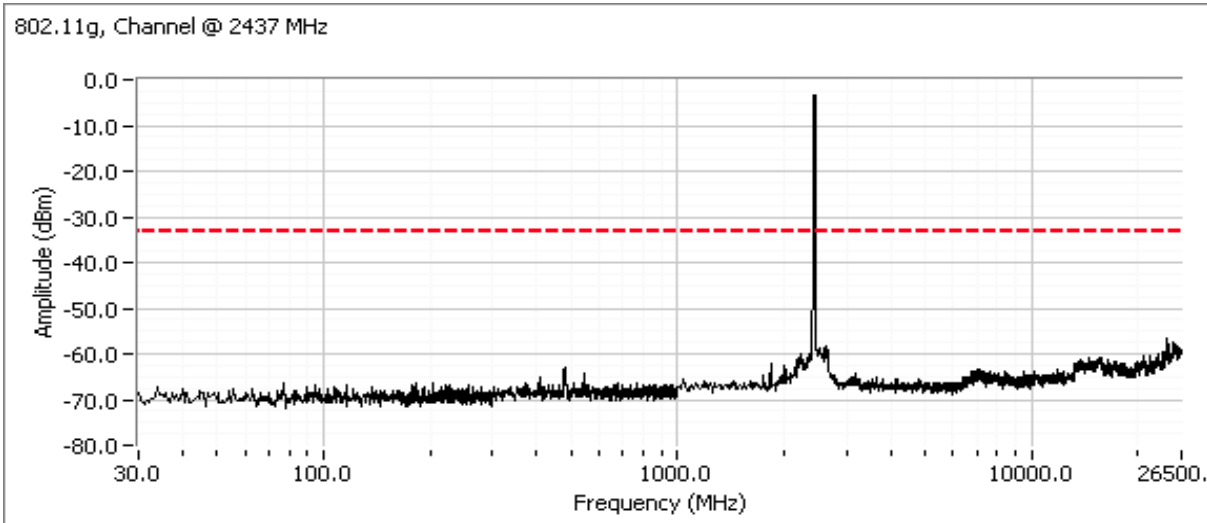

Plots for high channel, power setting(s) = 100 %

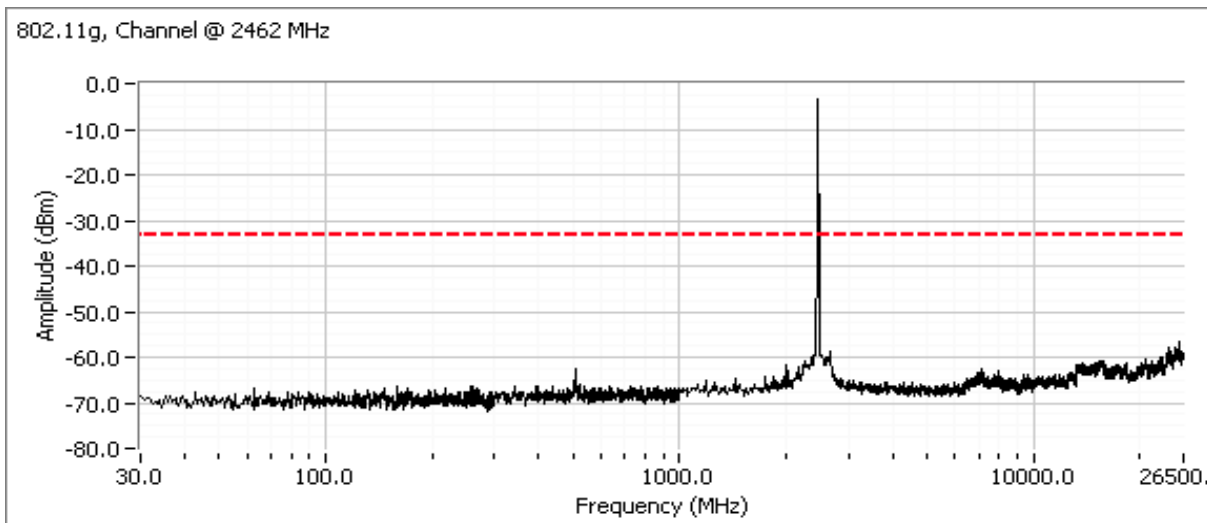

Client: Summit Data Communications	Job Number: J74548
Model: 802.11abg Compact Flash Card	T-Log Number: T74640
	Account Manager: Christine Krebill
Contact: Jerry Pohmurski	
Standard: FCC 15.247/RSS 210	Class: N/A

Additional plot from 2483.5 - 2500 MHz showing compliance with -30dBc at the band edge.

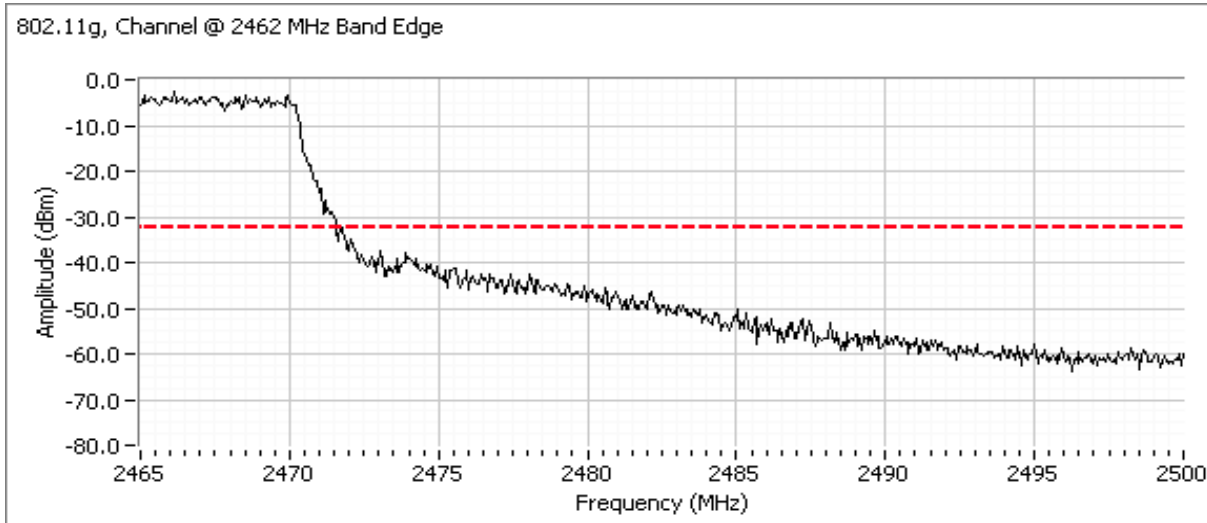

Client:	Summit Data Communications	Job Number:	J74548
Model:	802.11abg Compact Flash Card	T-Log Number:	T74640
		Account Manager:	Christine Krebill
Contact:	Jerry Pohmurski		
Standard:	FCC 15.247/RSS 210	Class:	N/A

RSS 210 and FCC 15.247 (DTS) Antenna Port Measurements Power, PSD, Bandwidth and Spurious Emissions

Test Specific Details

Objective: The objective of this test session is to perform final qualification testing of the EUT with respect to the specification listed above.

Date of Test: 3/5&6/2009
Test Engineer: Suhaila Khushzad
Test Location: SVOATS #1

Config. Used: 1
Config Change: None
EUT Voltage: 120V/60Hz

General Test Configuration

The EUT was connected to the spectrum analyzer or power meter via a suitable attenuator. All measurements were made on a single chain.

All measurements have been corrected to allow for the external attenuators used.

Ambient Conditions:
Temperature: 10.6 °C
Rel. Humidity: 76 %

Summary of Results

Run #	Pwr setting	Avg Pwr	Test Performed	Limit	Pass / Fail	Result / Margin
1	100%	-	Output Power	15.247(b)	Pass	11.6dBm(14.5mW)
2	100%	-	Power spectral Density (PSD)	15.247(d)	Pass	-6.2 dBm/3kHz
3	100%	-	Minimum 6dB Bandwidth	15.247(a)	Pass	16.5 MHz
3	100%	-	99% Bandwidth	RSS GEN	-	17.5 MHz
4	100%	-	Spurious emissions	15.247(b)	Pass	All emissions below the -30dBc limit

Modifications Made During Testing

No modifications were made to the EUT during testing

Deviations From The Standard

No deviations were made from the requirements of the standard.

Client: Summit Data Communications	Job Number: J74548
Model: 802.11abg Compact Flash Card	T-Log Number: T74640
	Account Manager: Christine Krebill
Contact: Jerry Pohmurski	
Standard: FCC 15.247/RSS 210	Class: N/A

Run #1: Output Power

Power Setting ²	Frequency (MHz)	Output Power		Antenna Gain (dBi)	Result	EIRP ^{Note 2}		Output Power	
		(dBm) ¹	mW			dBm	W	(dBm) ³	mW
100%	5745	10.6	11.4	5.0	Pass	15.6	0.036		
100%	5785	11.6	14.5	5.0	Pass	16.6	0.046		
100%	5805	11.6	14.4	5.0	Pass	16.6	0.046		

- Note 1: Output power measured using a spectrum analyzer (see plots below):
 RBW=1MHz, VB=3 MHz, sample detector, power averaging on (transmitted signal was continuous) and power integration over 50 MHz. **Spurious limit is -30dBc because this method was used.**
- For Channel 161 (5805 MHz), the RBW=1MHz, VB=3 MHz, sample detector, max hold for at least 60 seconds (transmitted signal was not continuous) and power integration over 50 MHz.
- Note 2: Power setting - the software power setting used during testing, included for reference only.

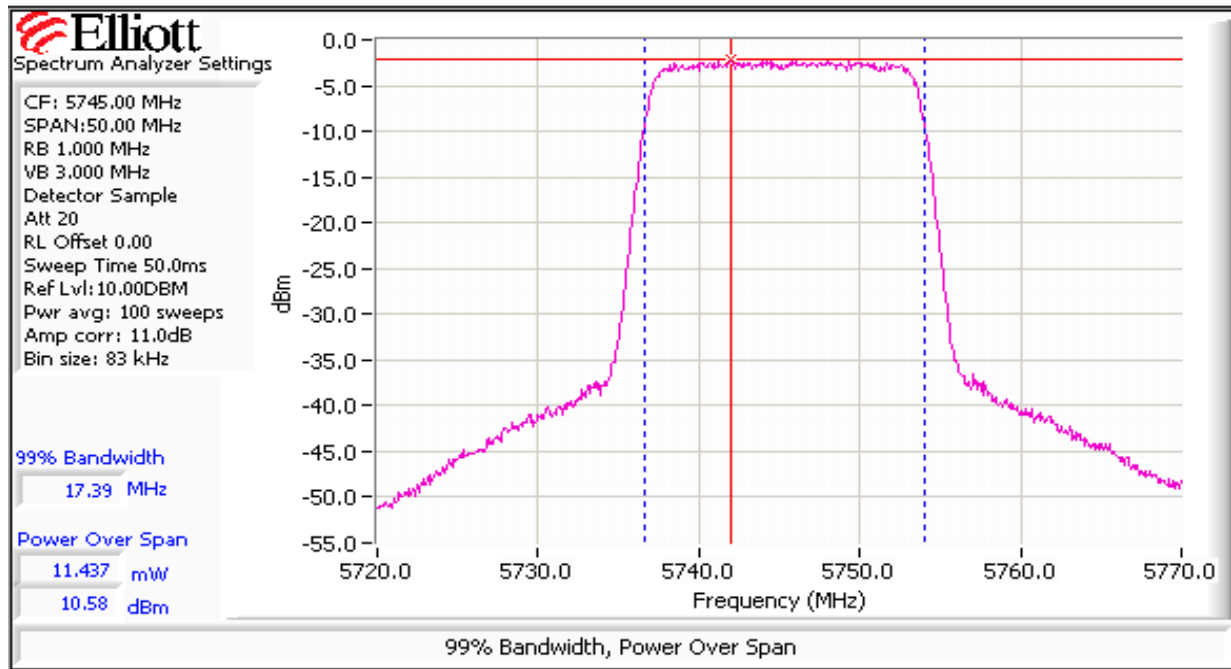

Client: Summit Data Communications	Job Number: J74548
Model: 802.11abg Compact Flash Card	T-Log Number: T74640
	Account Manager: Christine Krebill
Contact: Jerry Pohmurski	
Standard: FCC 15.247/RSS 210	Class: N/A

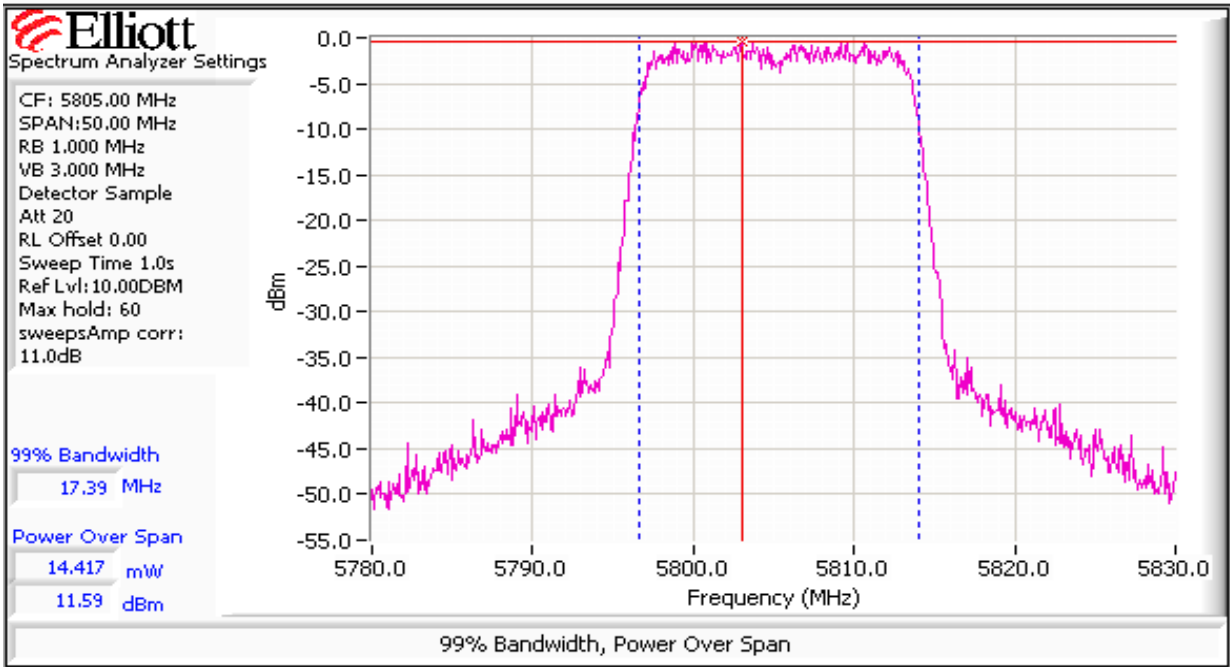
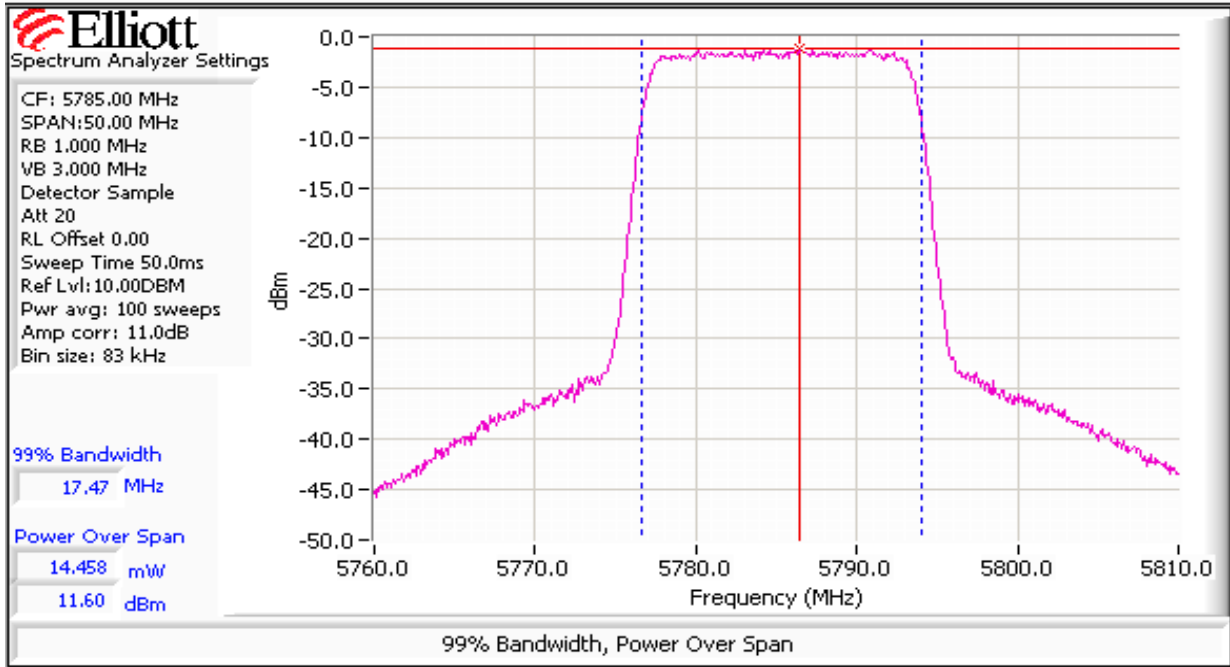

Note 3: For Channel 161 (5805 MHz), the RBW=1MHz, VB=3 MHz, sample detector, max hold for **at least 60 seconds** (transmitted signal was not continuous) and power integration over 50 MHz.

Client: Summit Data Communications	Job Number: J74548
Model: 802.11abg Compact Flash Card	T-Log Number: T74640
	Account Manager: Christine Krebill
Contact: Jerry Pohmurski	
Standard: FCC 15.247/RSS 210	Class: N/A

Run #2: Power spectral Density

Power Setting	Frequency (MHz)	PSD	Limit dBm/3kHz	Result
		(dBm/3kHz) ^{Note 1}		
100%	5745	-6.2	8.0	Pass
100%	5785	-15.0	8.0	Pass
100%	5805	-19.1	8.0	Pass

Note 1: Power spectral density measured using RB=3 kHz, VB=10kHz, analyzer with peak detector and with a sweep time set to ensure a dwell time of at least 1 second per 3kHz. The measurement is made at the frequency of PPSD determined from preliminary scans using

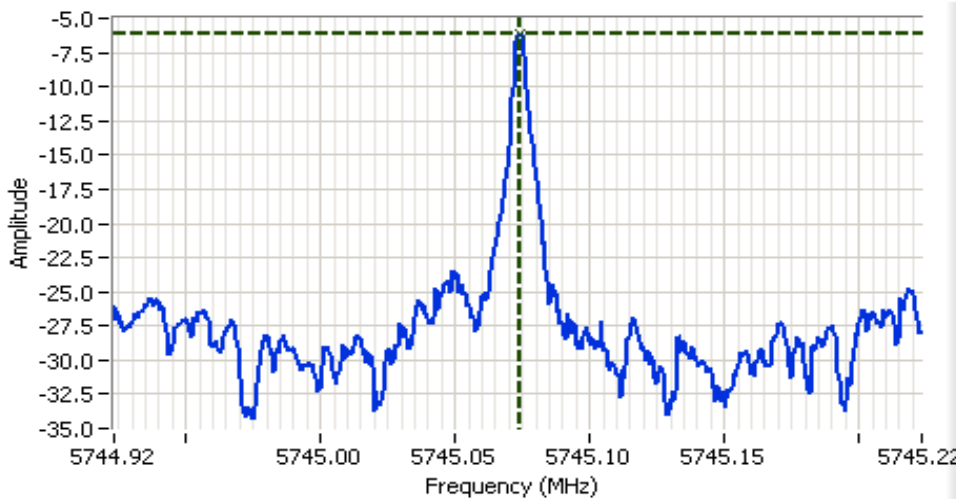

Analyzer Settings

HP8564E
 CF: 5745.073 MHz
 SPAN: 300 kHz
 RB 3.00 kHz
 VB 10.00 kHz
 Detector POS
 Att 20
 RL Offset 11.00
 Sweep Time 100.0s
 Ref Lvl: 21.00DBM

Comments

Cursor 1 5745.0742 -6.17 ⊕ ⊖ ⊞ ⊚

0.0000 0.00 ⊕ ⊖ ⊞ ⊚

Client: Summit Data Communications	Job Number: J74548
Model: 802.11abg Compact Flash Card	T-Log Number: T74640
	Account Manager: Christine Krebill
Contact: Jerry Pohmurski	
Standard: FCC 15.247/RSS 210	Class: N/A

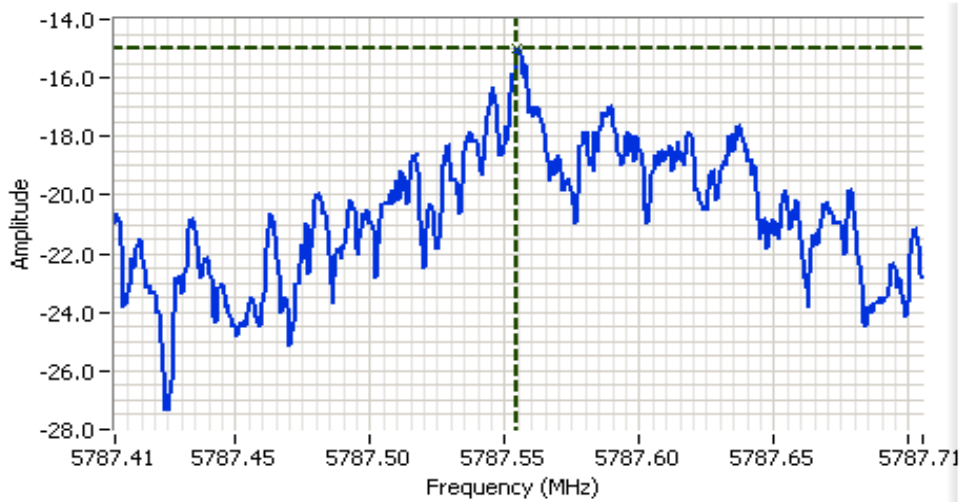

Analyzer Settings

HP8564E
 CF: 5787.555 MHz
 SPAN: 300 kHz
 RB 3.00 kHz
 VB 10.00 kHz
 Detector POS
 Att 20
 RL Offset 11.00
 Sweep Time 100.0s
 Ref Lvl: 21.00DBM

Comments

PSD: -15dBm/3kHz

Cursor 1 5787.5547 -15.00

0.0000 0.00

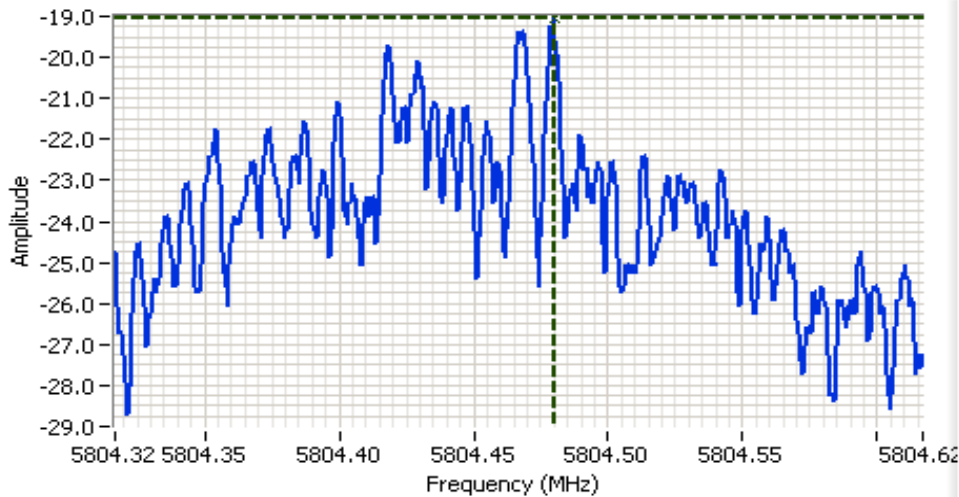

Analyzer Settings

HP8564E
 CF: 5804.467 MHz
 SPAN: 300 kHz
 RB 3.00 kHz
 VB 10.00 kHz
 Detector POS
 Att 20
 RL Offset 11.00
 Sweep Time 100.0s
 Ref Lvl: 11.10DBM

Comments

Cursor 1 5804.4798 -19.07

0.0000 0.00



Client: Summit Data Communications	Job Number: J74548
Model: 802.11abg Compact Flash Card	T-Log Number: T74640
	Account Manager: Christine Krebill
Contact: Jerry Pohmurski	
Standard: FCC 15.247/RSS 210	Class: N/A

Run #3: Signal Bandwidth

Power Setting	Frequency (MHz)	Resolution Bandwidth	Bandwidth (MHz)	
			6dB	99%
100%	5745	100kHz	16.5	17.39
100%	5785	100kHz	16.5	17.47
100%	5805	100kHz	16.5	17.39

Note 1: 99% bandwidth measured in accordance with RSS GEN, with RB > 1% of the span and VB > 3xRB

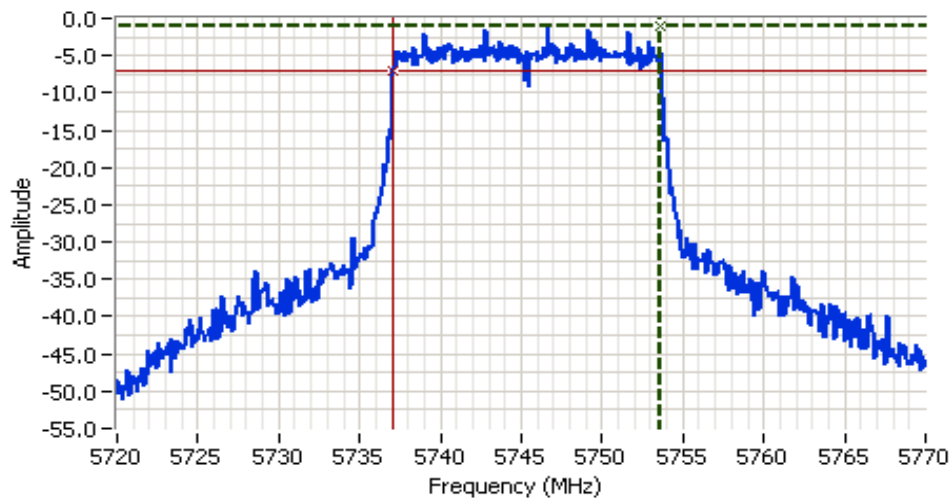

Analyzer Settings

HP8564E
 CF: 5745.000 MHz
 SPAN: 50.000 MHz
 RB 100 kHz
 VB 100 kHz
 Detector POS
 Att 10
 RL Offset 11.00
 Sweep Time 50.0ms
 Ref Lvl: 11.00DBM

Comments

6dB BW: 16.500 MHz

Cursor 1	5753.5833	-1.17	⊕ ⊖	Delta Freq.	16.500
Cursor 2	5737.0833	-7.17	⊕ ⊖	Delta Amplitude	6.00



Client: Summit Data Communications	Job Number: J74548
Model: 802.11abg Compact Flash Card	T-Log Number: T74640
Contact: Jerry Pohmurski	Account Manager: Christine Krebill
Standard: FCC 15.247/RSS 210	Class: N/A

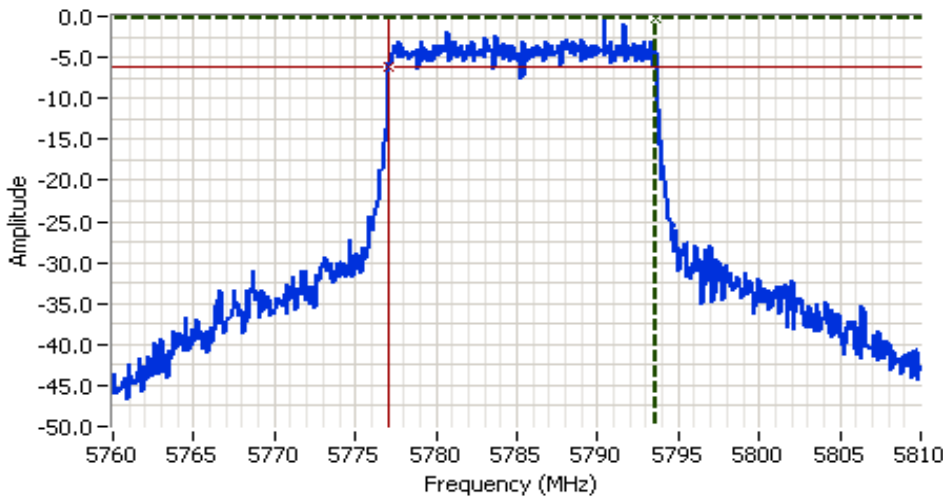

Analyzer Settings

HP8564E
 CF: 5785.000 MHz
 SPAN: 50.000 MHz
 RB 100 kHz
 VB 100 kHz
 Detector POS
 Att 10
 RL Offset 11.00
 Sweep Time 50.0ms
 Ref Lvl: 11.00DBM

Comments

6dB BW: 16.500 MHz

Cursor 1 5793.5833 -0.17

Cursor 2 5777.0833 -6.17

Delta Freq. 16.500

Delta Amplitude 6.00

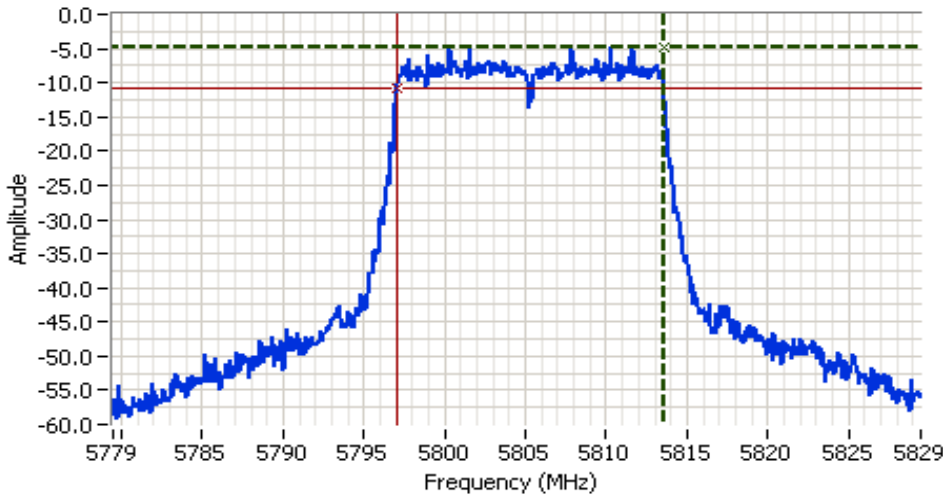

Analyzer Settings

HP8564E
 CF: 5804.467 MHz
 SPAN: 50.000 MHz
 RB 100 kHz
 VB 100 kHz
 Detector POS
 Att 20
 RL Offset 11.00
 Sweep Time 50.0ms
 Ref Lvl: 11.10DBM

Comments

6dB BW: 16.500 MHz

Cursor 1 5813.5501 -4.73

Cursor 2 5797.0501 -10.73

Delta Freq. 16.500

Delta Amplitude 6.00



Client: Summit Data Communications	Job Number: J74548
Model: 802.11abg Compact Flash Card	T-Log Number: T74640
	Account Manager: Christine Krebill
Contact: Jerry Pohmurski	
Standard: FCC 15.247/RSS 210	Class: N/A

Run #4: Out of Band Spurious Emissions

Frequency (MHz)	Limit	Result
5745	-30dBc	Pass
5785	-30dBc	Pass
5805	-20dBc	Pass

Plots for low channel, power setting(s) = 100 %

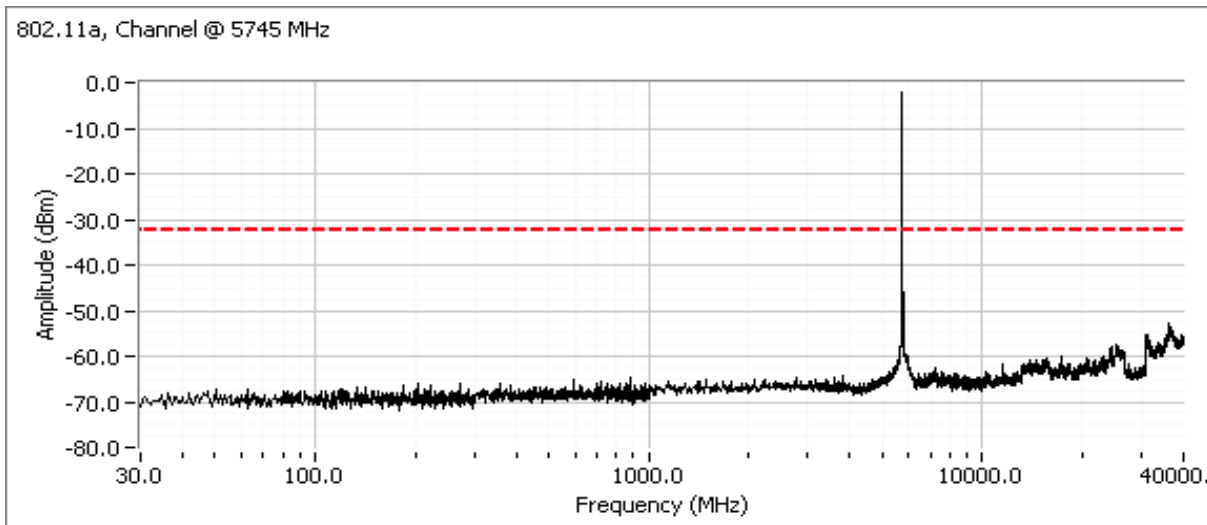

Plots for center channel, power setting(s) = 100 %

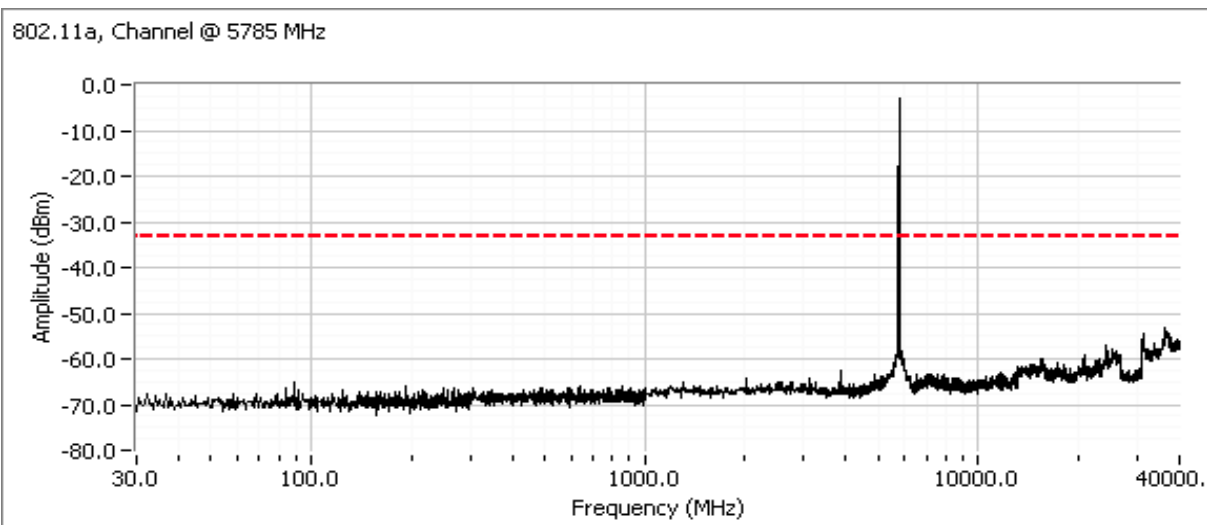

Client:	Summit Data Communications	Job Number:	J74548
Model:	802.11abg Compact Flash Card	T-Log Number:	T74640
Contact:	Jerry Pohmurski	Account Manager:	Christine Krebill
Standard:	FCC 15.247/RSS 210	Class:	N/A

Plots for high channel, power setting(s) = 100 %

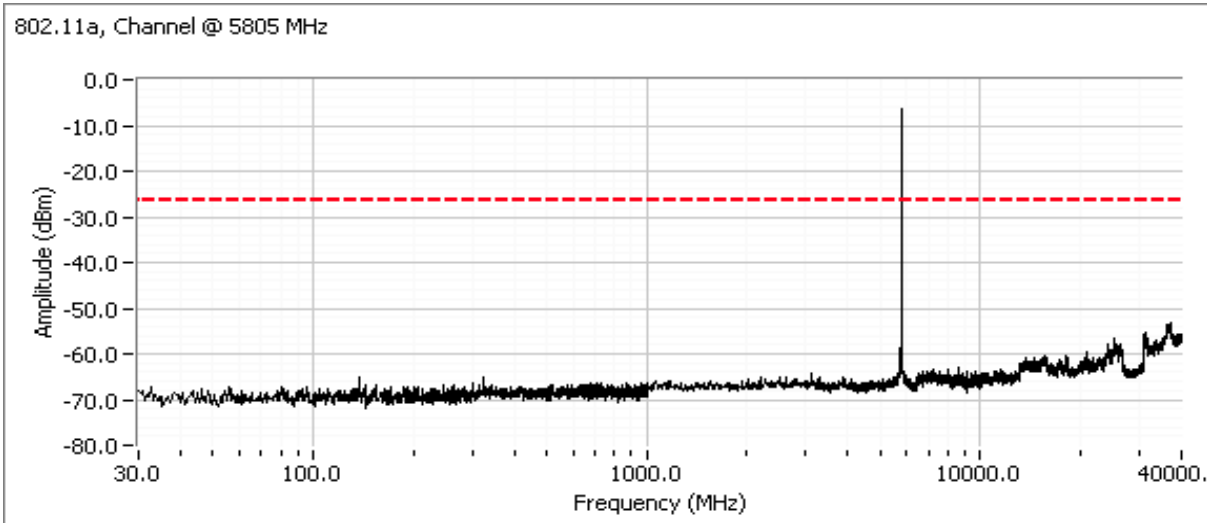

Additional plot from 5810 - 5850 MHz showing compliance with -30dBc at the band edge.

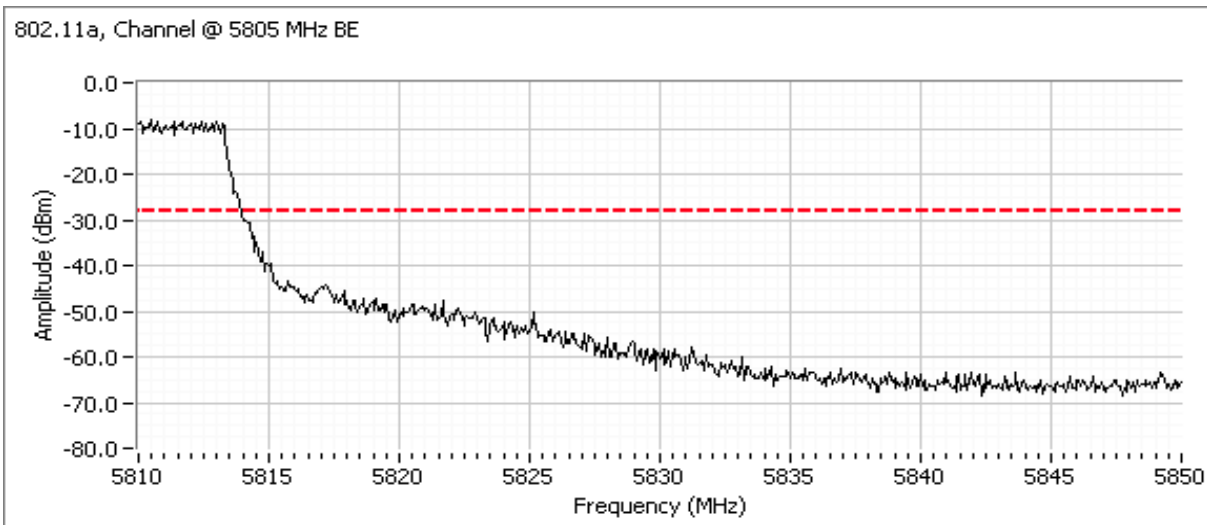

EXHIBIT 3: Photographs of Test Configurations

EXHIBIT 4: Proposed FCC ID Label & Label Location

EXHIBIT 5: Detailed Photographs

EXHIBIT 6: Operator's Manual

EXHIBIT 7: Block Diagram

EXHIBIT 8: Schematic Diagrams

EXHIBIT 9: Theory of Operation

EXHIBIT 10: RF Exposure Information